

IERG4300/ IEMS5709
Web-scale Information Analytics

MapReduce and Related
Systems

Prof. Wing C. Lau
Department of Information Engineering
wclau@ie.cuhk.edu.hk

Acknowledgements

- The slides used in this chapter are adapted from the following sources:
 - “Data-Intensive Information Processing Applications,” by Jimmy Lin, University of Maryland.



This work is licensed under a Creative Commons Attribution-Noncommercial-Share Alike 3.0 United States. See <http://creativecommons.org/licenses/by-nc-sa/3.0/us/> for details

- CS246 Mining Massive Data-sets, by Jure Leskovec, Stanford University.
- “Data Management in the Cloud – Advanced Topics in Databases,” by Saake, Schallehn, Mohammad of OvGU, Summer 2011.
- Introduction to Advanced Computing Platform for Data Analysis, by Ruoming Jin, Kent University.
- “Intro To Hadoop” in UC Berkeley i291 - Analyzing BigData with Twitter, by Bill Graham, Twitter.
- All copyrights belong to the original authors of the material.

How do we scale-up for Web-Scale Information Analytics ?

Divide and Conquer

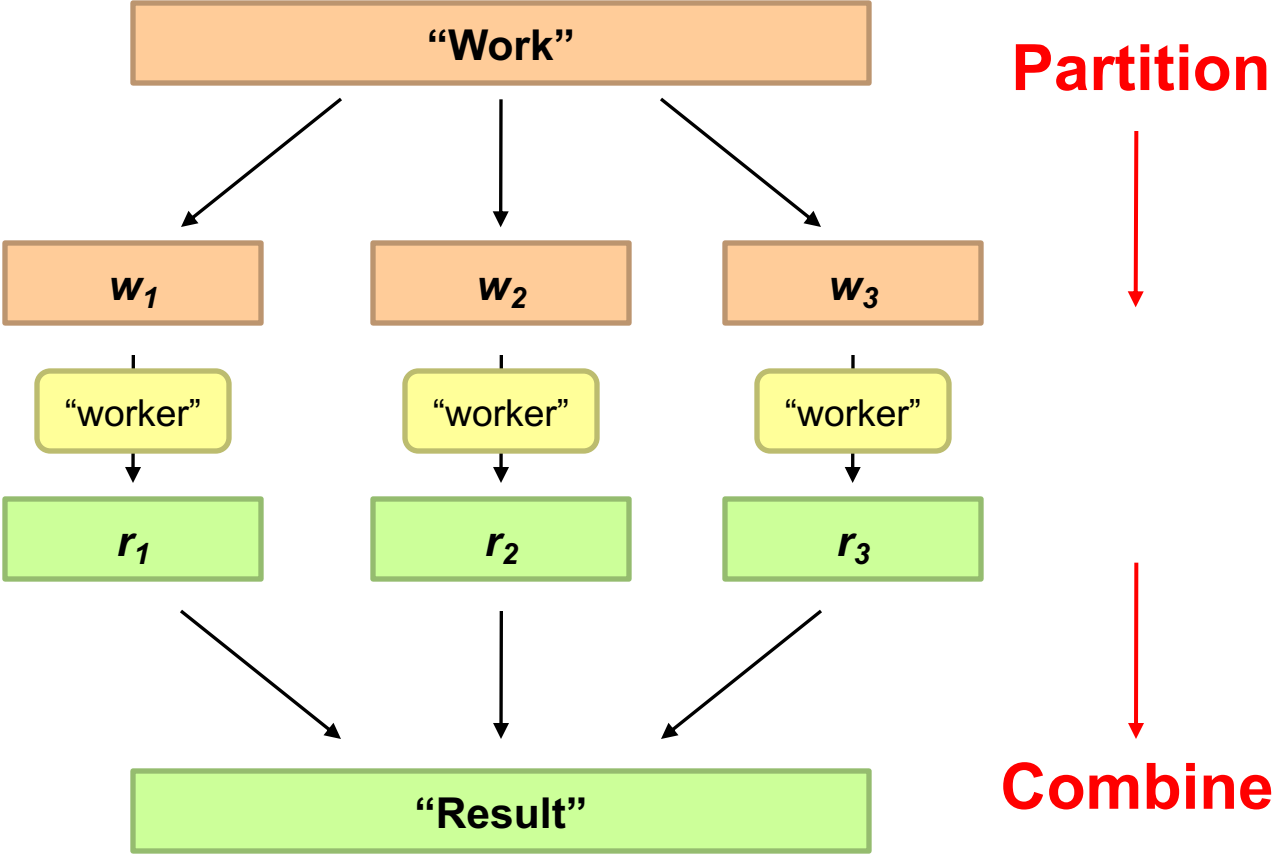

Parallelization Challenges

- How do we assign work units to workers?
- What if we have more work units than workers?
- What if workers need to share partial results?
- How do we aggregate partial results?
- How do we know all the workers have finished?
- What if workers die?

What is the common theme of all of these problems?

Common Theme?

- Parallelization problems arise from:
 - Communication between workers (e.g., to exchange state)
 - Access to shared resources (e.g., data)
- Thus, we need a synchronization mechanism



Source: Ricardo Guimarães Herrmann

Managing Multiple Workers

- Difficult because
 - We don't know the order in which workers run
 - We don't know when workers interrupt each other
 - We don't know the order in which workers access shared data
- Thus, we need:
 - Semaphores (lock, unlock)
 - Conditional variables (wait, notify, broadcast)
 - Barriers
- Still, lots of problems:
 - Deadlock, livelock, race conditions...
 - Dining philosophers, sleeping barbers, cigarette smokers...
- Moral of the story: be careful!

Common Tools to facilitate Parallel Programming

- Programming models
 - Shared memory (pthreads)
 - Message passing (MPI)
- Design Patterns
 - Master-slaves
 - Producer-consumer flows
 - Shared work queues

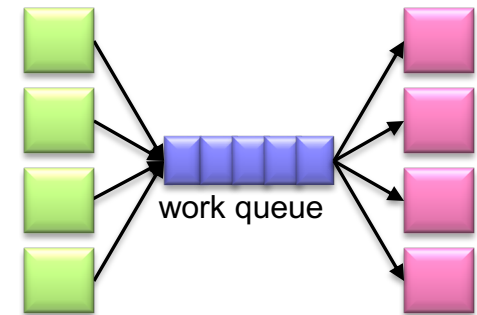
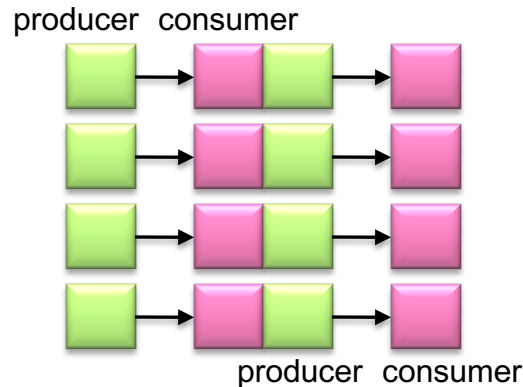
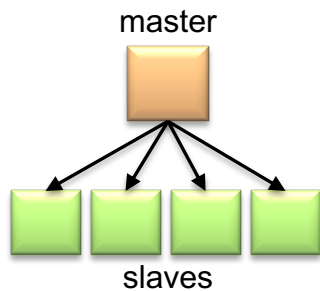
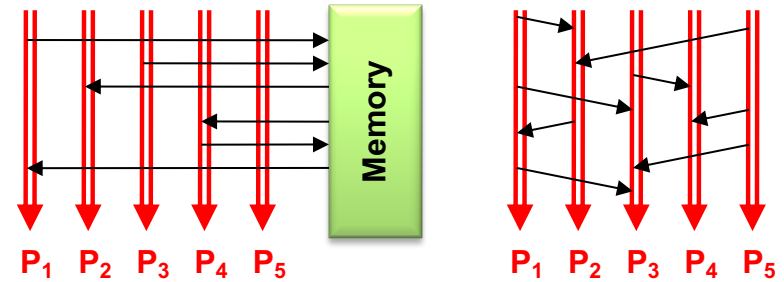

Where the rubber meets the road

- Concurrency is difficult to reason about
- Concurrency is even more difficult to reason about
 - At the scale of datacenters (even across datacenters)
 - In the presence of failures
 - In terms of multiple interacting services
- Not to mention debugging...
- The reality:
 - Lots of one-off solutions, custom code
 - Write you own dedicated library, then program with it
 - Burden on the programmer to explicitly manage everything



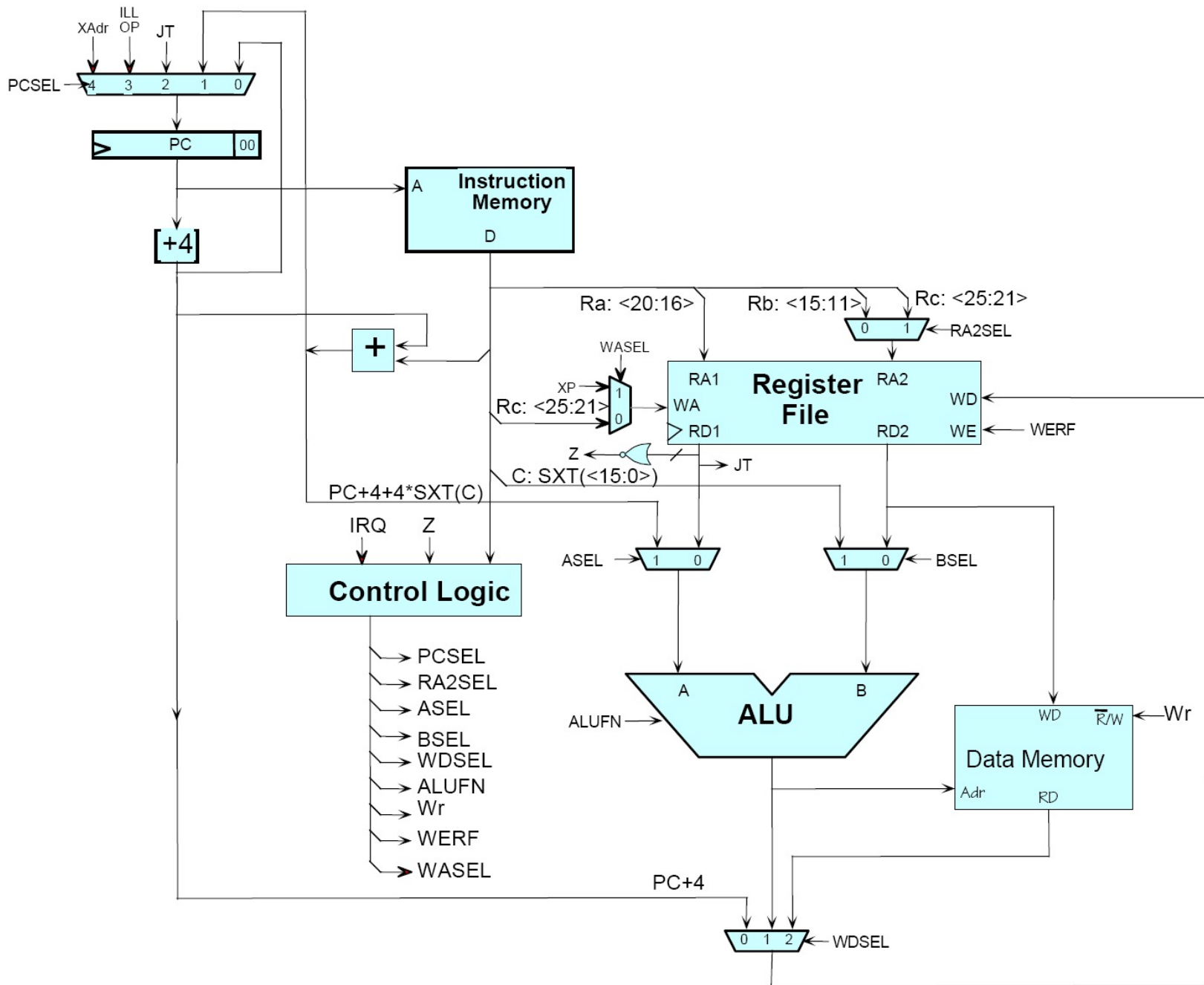



UTILITY CONNECTIONS:

BUILDING	SPRINKLER SYSTEM	DOMESTIC WATER	PLANT WATER	SANITARY SEWER
BUILDING 1	8" & 6"	3"	(2)-4"	6" & 4"
BUILDING 2	8" & 6"	3"	(2)-4"	6" & 4"
BUILDING 3	8" & 6"	3"	(2)-4"	6" & 4"
ADMIN. BUILDING	6"	3"	--	6"
HOUSING BUILDING	6"	4"	--	6"

LEGEND

- MH = MANHOLE
- (---) --- = EXISTING SANITARY SEWER
- (---) --- = PROPOSED SANITARY SEWER
- (---) --- = EXISTING STORM SEWER
- (---) --- = PROPOSED STORM SEWER
- CB = CATCH BASIN
- CO = CLEAN OUT
- = EXISTING WATER LINE
- FA = FIRE HYDRANT
- WV = WATER VALVE
- B.O.V. = BLOW-OFF VALVE
- = NATURAL GAS LINE
- = OVERHEAD TELEPHONE CABLE
- = UNDERGROUND TELEPHONE CABLE
- = FIBER OPTIC TELEPHONE CABLE
- = CABLE TELEVISION LINE
- = OVERHEAD ELECTRIC POWER LINE
- = UNDERGROUND ELECTRIC POWER LINE
- = EXISTING POWER POLE
- = EXISTING FENCE LINE
- TP = TELEPHONE RISER
- GM = GAS METER
- EM = ELECTRICAL BOX
- EV = ELECTRICAL VAULT
- WM = WATER METER
- SL = STREET LIGHT
- SK = STREET SIGN
- = EXISTING CONTOUR LINE
- NOTE: ALL OTHERS AS NOTED ON PLAN

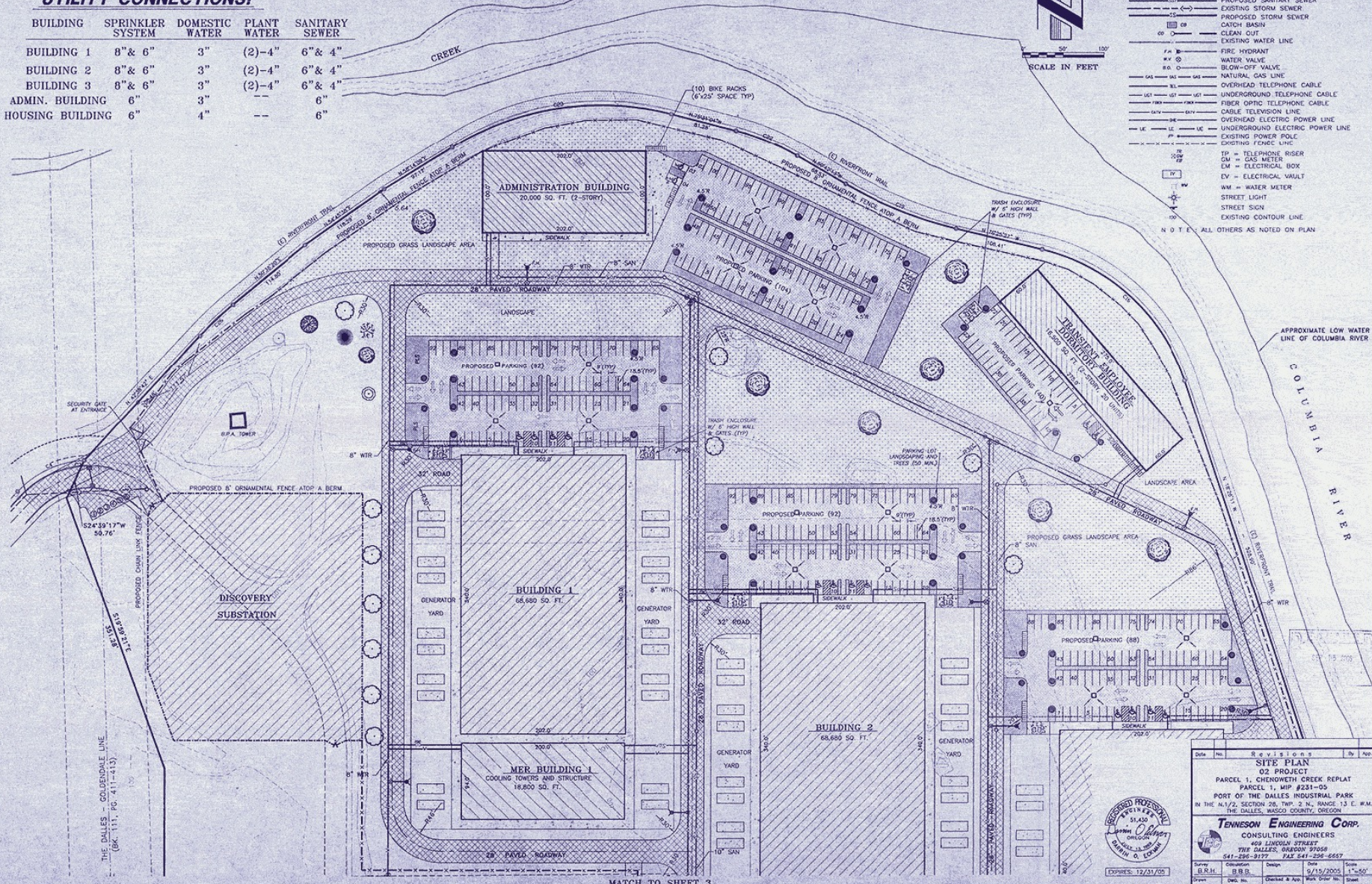

Revisions

Date	No.	Description
	02	PROJECT
	01	SITE PLAN

02 PROJECT
 PARCEL 1, CHENOWETH CREEK REPLAT
 PARCEL 1, MIP #231-05
 PORT OF THE DALLES INDUSTRIAL PARK
 IN THE N.1/2, SECTION 28, TWP. 2 N., RANGE 13 E. W.M.
 THE DALLES, WASCO COUNTY, OREGON

TENNESON ENGINEERING CORP.
 CONSULTING ENGINEERS
 409 LINCOLN STREET
 THE DALLES, OREGON 97058
 (503) 325-3177 FAX 541-298-6657

Scale: 1" = 50'

Drawn: S.O.H. Date: 9/15/2005 Sheet: 7 of 3

Checked & App: R.B.B. Mark Order No: 11690

EXP. DATE: 12/31/2005

MATCH TO SHEET 3

CONFIDENTIAL / PROPRIETARY - SUBJECT TO EXEMPTION OF 5 U.S.C. §552(b)(4)

What's the point?

- It's all about the right level of abstraction
 - The von Neumann architecture has served us well, but is no longer appropriate for the multi-core/cluster environment
- Hide system-level details from the developers
 - No more race conditions, lock contention, etc.
- Separating the *what* from *how*
 - Developer specifies the computation that needs to be performed
 - Execution framework (“runtime”) handles actual execution

The datacenter *is* the computer!

“Big Ideas”

- Scale “out”, not “up”
 - Limits of SMP and large shared-memory machines
- Move processing to the data
 - Cluster have limited bandwidth
- Process data sequentially, avoid random access
 - Seeks are expensive, disk throughput is reasonable
- Seamless scalability
 - From the mythical man-month to the tradable machine-hour

Computational Model for Web-scale Information Processing: MapReduce

Google MapReduce

- Framework for parallel processing in large-scale **shared-nothing architecture**
- Developed initially (**and patented**) by Google to handle Search Engine's webpage indexing and page ranking in a more systematic and maintainable fashion
- **Why NOT** using existing Database (DB)/ Relational Database Management **Systems (RDMS) technologies?**

Mismatch of Objectives

- DB/ RDMS were designed for high-performance transactional processing to support hard guarantees on consistencies in case of **MANY** concurrent (**often small**) updates, e.g. ebanking, airline ticketing ; DB Analytics were “secondary” functions added on later ;
- For Search Engines, the documents are never updated (till next Web Crawl) and they are Read-Only ; It is ALL about Analytics !
- Import the webpages, convert them to DB storage format is expensive
- The Job was simply too big for prior DB technologies !

Typical BigData Problem

- Iterate over a large number of records

Map ○ Extract something of interest from each

- Shuffle and sort intermediate results

- Aggregate intermediate results

- Generate final output

Reduce

Key idea: provide a functional abstraction for these two operations

Roots in Functional Programming

Map

Fold

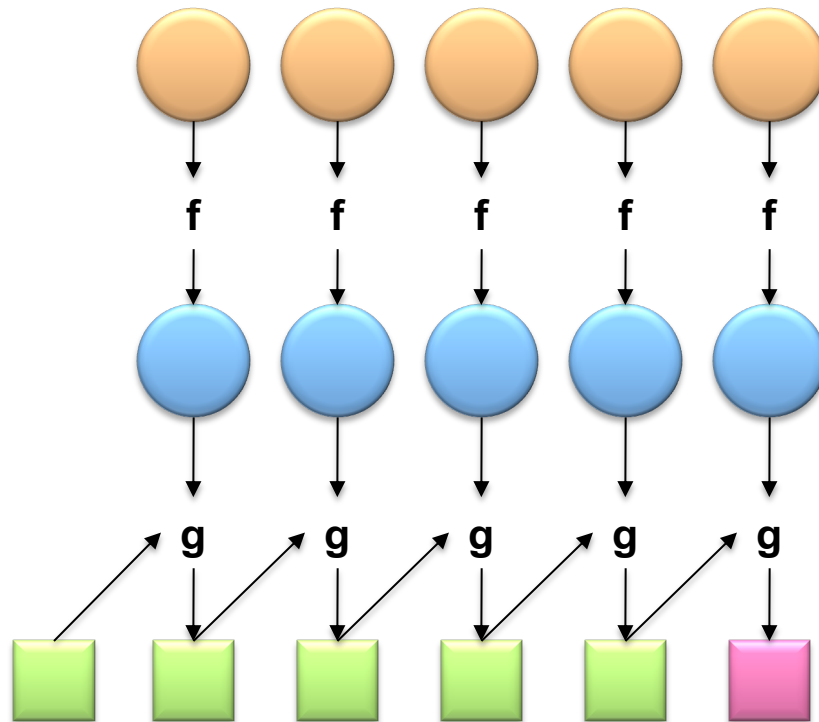

MapReduce

- Programmers specify two functions:
 - map** $(k, v) \rightarrow \langle k', v' \rangle^*$
 - reduce** $(k', v') \rightarrow \langle k'', v'' \rangle^*$
 - All values with the same key are sent to the same reducer
 - $\langle a, b \rangle^*$ means a list of tuples in the form of (a, b)
- The execution framework handles everything else...

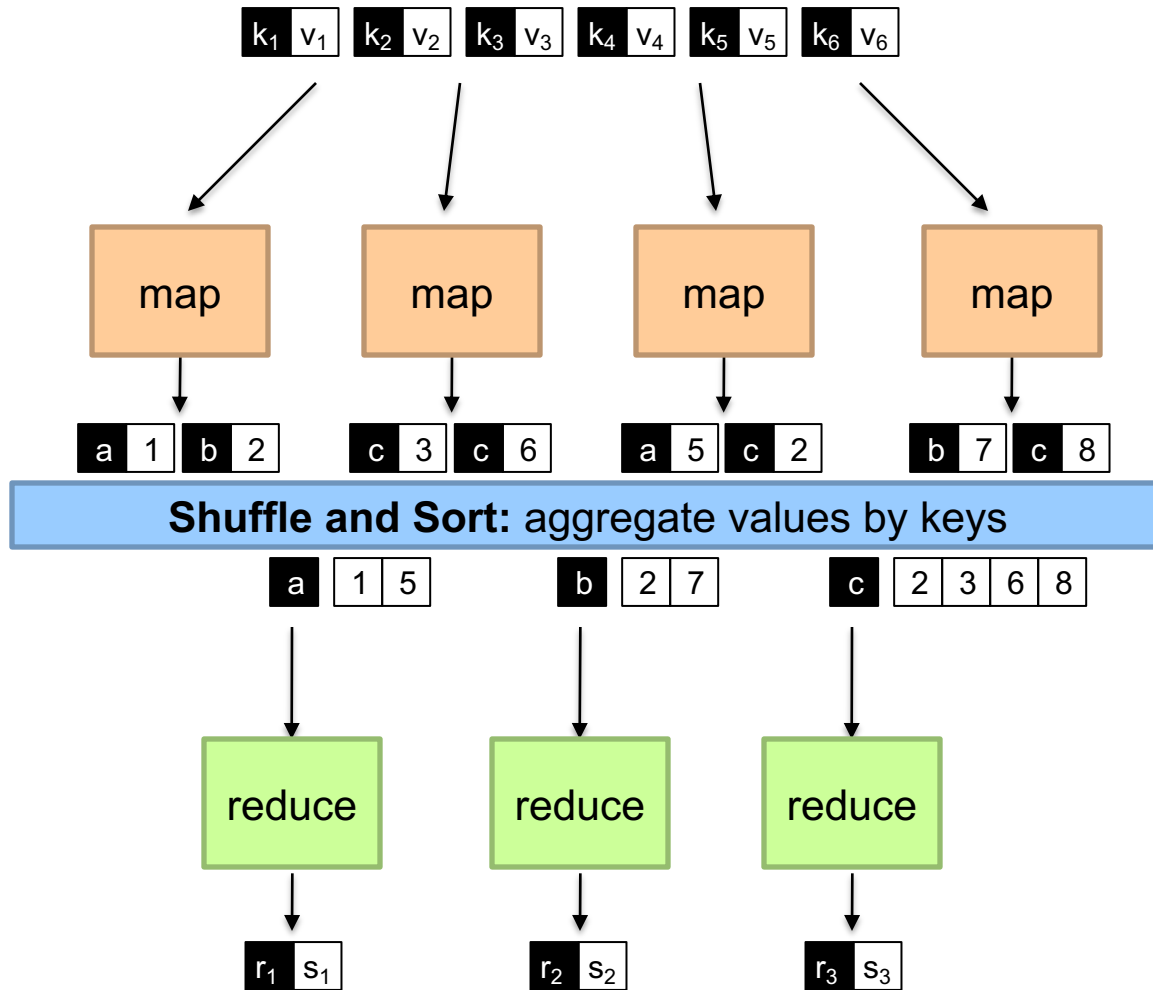

MapReduce: Word Counting

Provided by the programmer

MAP:
Read input and produces a set of key-value pairs

(The, 1)
(crew,1)
(of, 1)
(the,1)
(space,1)
(shuttle,1)
(Endeavor,1)
(recently,1)
(returned,1)
(to,1)
(Earth,1)
(as,1)
(ambassadors,1)
.....

(key, value)

Provided by the programmer

Group by key:
Collect all pairs with same key

(crew, 1)
(crew, 1)
(space, 1)

(the, 1)
(the, 1)
(the, 1)

(shuttle, 1)
(recently, 1)
.....

(key, value)

Reduce:
Collect all values belonging to the key and output

(crew, 2)
(space, 1)
(the, 3)
(shuttle, 1)
(recently, 1)
.....

(key, value)

The crew of the space shuttle Endeavor recently returned to Earth as ambassadors, harbingers of a new era of space exploration. Scientists at NASA are saying that the recent assembly of the Dextre bot is the first step in a long-term space-based man/mache partnership. "The work we're doing now -- the robotics we're doing -- is what we're going to need

Big Document

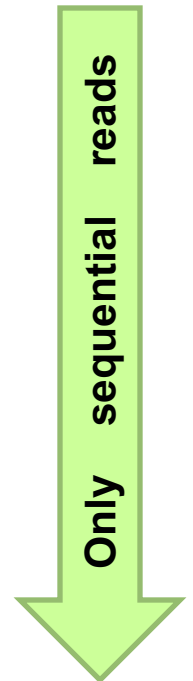

“Hello World”: Pseudo-code for Word Count

Map(String docid, String text):

```
// docid: document name, i.e. the input key ;  
// text: text in the document, i.e. the input value  
  for each word w in text:  
    EmitIntermediate(w, 1);
```

Reduce(String term, Iterator<Int> lvalues):

```
// term: a word, i.e. the intermediate key, also happens to be the output key here ;  
// lvalues: an iterator over counts (i.e. gives the list of intermediate values from Map)  
  int sum = 0;  
  for each v in lvalues:  
    sum += v ;  
  Emit(term, sum);
```

// The above is **pseudo-code only** ! True code is a bit more involved: needs to define how the input key/values are divided up and accessed, etc).

“Hello World” Task for MapReduce: Word Counting

- Unix/Linux shell command to Count occurrences of words in a file named `doc.txt`:
 - `words (doc.txt) | sort | uniq -c`
 - where `words` takes a file and outputs the words in it, **one word per line**
 - “`uniq`” stands for unique, is a true Unix command ; see its manpage to find out what “`uniq -c`” does
- The above “Unix/Linux-shell command” captures the essence of **MapReduce**
 - Great thing is that it is **naturally parallelizable**
- Compare to the “Hadoop Streaming” Command of:

```
$HADOOP_HOME/bin/hadoop jar $HADOOP_HOME/hadoop-streaming.jar \  
-input myInputDirs \  
-output myOutputDir \  
-mapper myPythonScript.py \  
-reducer /bin/wc \  
-file myPythonScript.py
```

source: http://hadoop.apache.org/docs/current/hadoop-streaming/HadoopStreaming.html#How_Streaming_Works

MapReduce

- Programmers specify two functions:
 - map** $(k, v) \rightarrow \langle k', v' \rangle^*$
 - reduce** $(k', v') \rightarrow \langle k'', v'' \rangle^*$
 - All values with the same key are sent to the same reducer
- The execution framework handles everything else...

What's “everything else”?

MapReduce “Runtime”

- Handles scheduling
 - Assigns workers to map and reduce tasks
- Handles “data distribution”
 - Moves processes to data
- Handles synchronization
 - Gathers, sorts, and shuffles intermediate data
- Handles errors and faults
 - Detects worker failures and restarts
- Everything happens on top of a distributed File System (later)

MapReduce

- Programmers specify two functions:

map $(k, v) \rightarrow \langle k', v' \rangle^*$

reduce $(k', v') \rightarrow \langle k'', v'' \rangle^*$

- All values with the same key are reduced together
- The execution framework handles everything else...
- Not quite...usually, programmers also specify:

partition $(k', \text{number of partitions}) \rightarrow \text{partition for } k'$

- Often a simple hash of the key, e.g., **hash(k') mod n**
- Divides up key space for parallel reduce operations
- **Sometimes useful to override the hash function:**
 - e.g., **hash(hostname(URL)) mod R** ensures URLs from a host end up in the same output file

combine $(k', v') \rightarrow \langle k', v' \rangle^*$

- Mini-reducers that run in memory after the map phase
- Used as an **optimization** to reduce network traffic
- Works only if Reduce function is Commutative and Associative

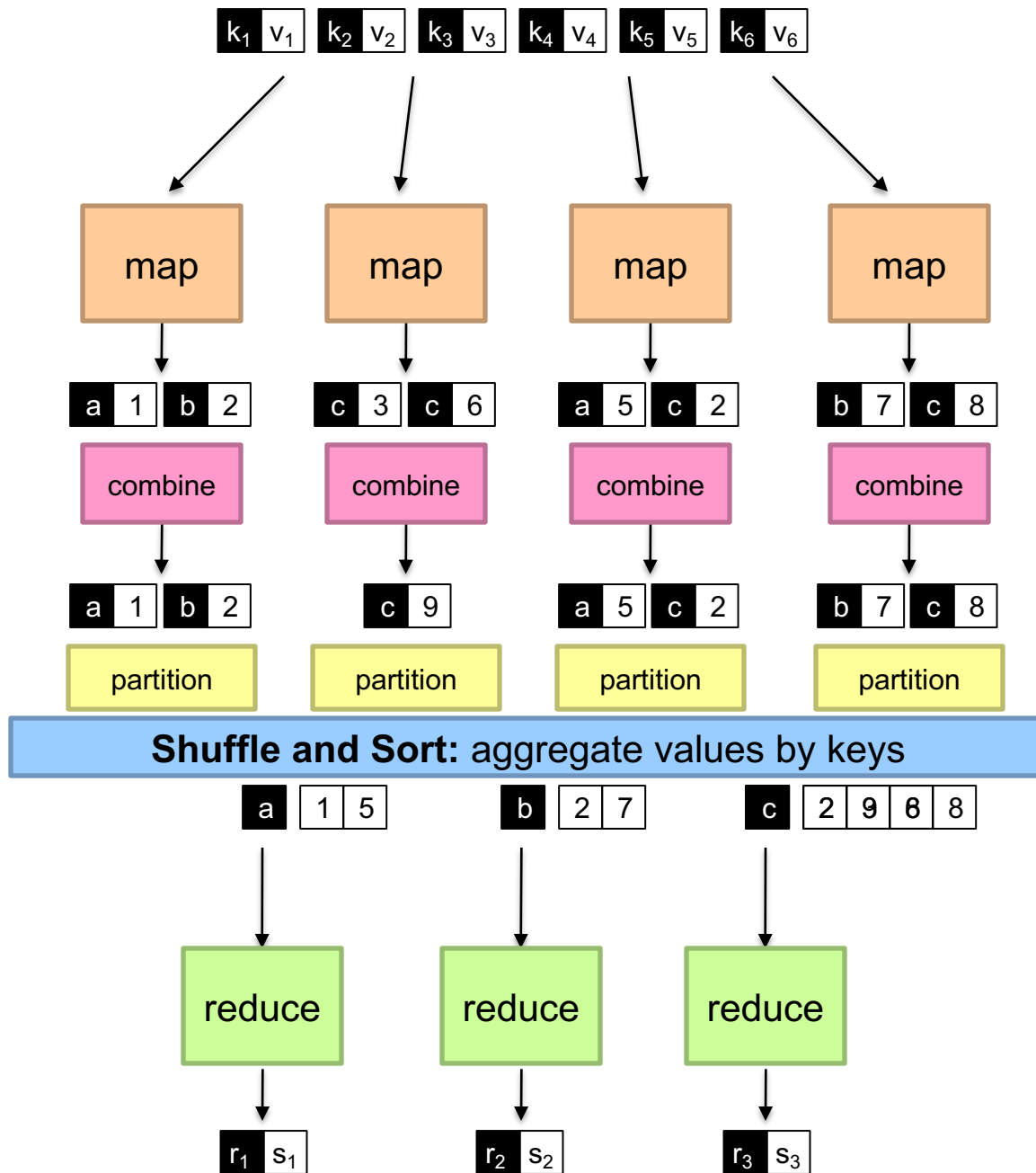

Two more details...

- Barrier between map and reduce phases
 - But we can begin copying intermediate data earlier
- Keys arrive at each reducer in sorted order
 - No enforced ordering *across* reducers
 - For tuples with the same intermediate key, Hadoop does not guarantee the ordering of values are in sorted order when presenting to the reducer
 - In contrast, Google's MapReduce Implementation supports the “secondary sorting” option to make tuples with same intermediate keys are sorted by their values. One can emulate such behavior in Hadoop by using the “value-to-key” trick and a customized partitioner and sorter.

Example 2: Inverted Index (for a Search Engine)

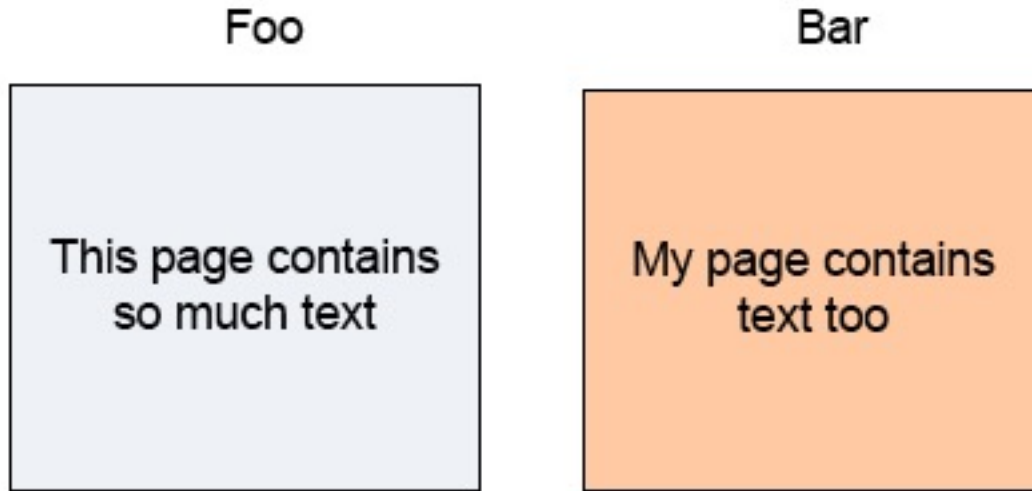

contains: Foo, Bar
much: Foo
My: Bar
page : Foo, Bar
so : Foo
text: Foo, Bar
This : Foo
too: Bar

Inverted Index with MapReduce

- Mapper:

- Key: PageName // URL of webpage
 - Value: Text // text in the webpage
- foreach word w in Text
EmitIntermediate(w , PageName)

- Reducer:

- Key: word
- Values: all URLs for word
- ... Just the Identity function

Inverted Index Data flow w/ MapReduce

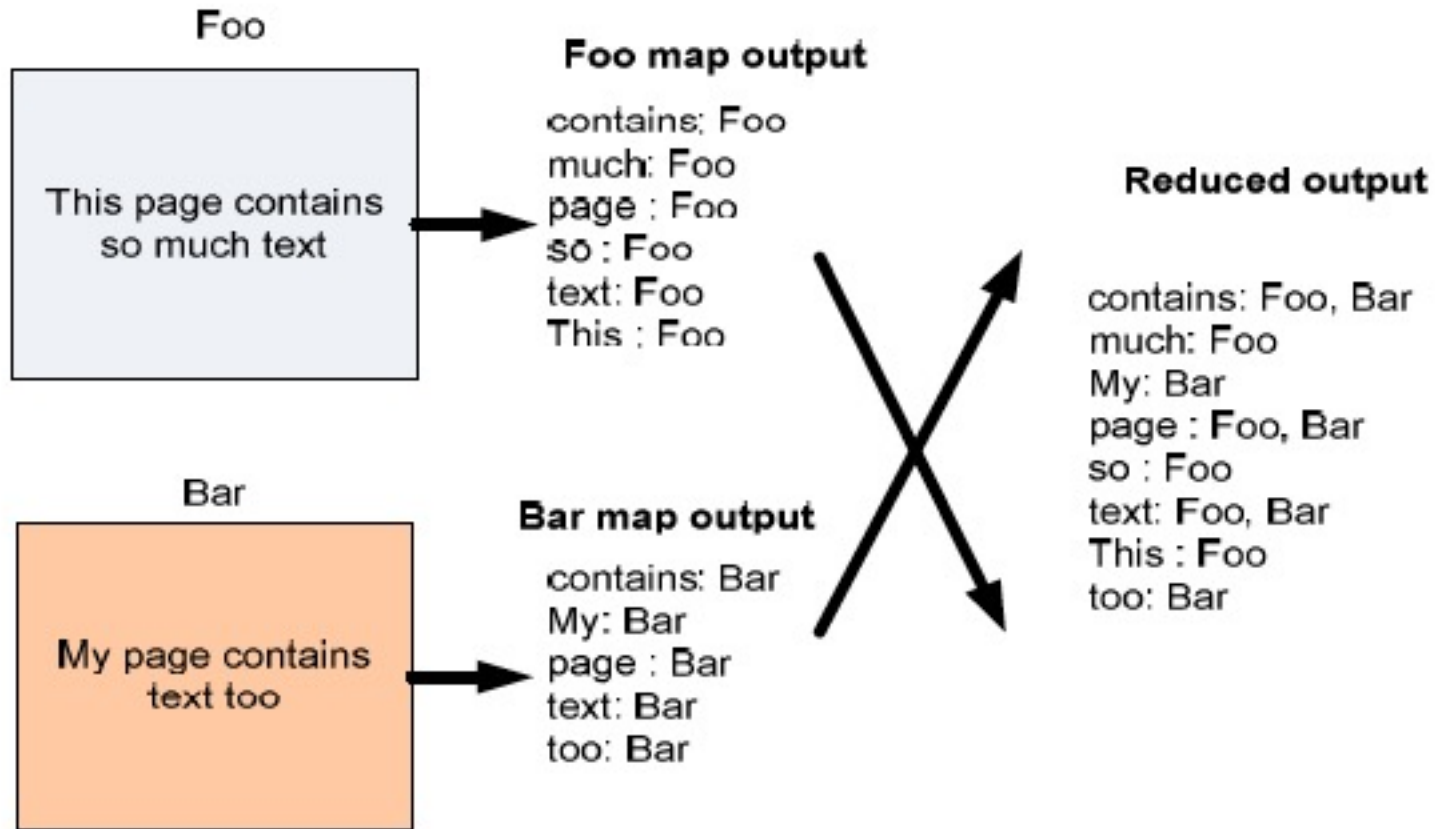

More Sample Use of MapReduce

More MapReduce Example: Host size

- **Suppose we have a large web corpus**
- Look at the metadata file
 - Lines of the form: (URL, size, date, ...)
- **For each host, find the total number of bytes**
 - That is, the sum of the page sizes for all URLs from that particular host
- **Other examples:**
 - Link analysis and graph processing
 - Machine Learning algorithms
 - More later in the course...

Another Example: Language Model

- **Statistical machine translation:**
 - Need to count number of times every 5-word sequence occurs in a large corpus of documents
- **With MapReduce:**
 - **Map:**
 - Extract (5-word sequence, count) from document
 - **Reduce:**
 - Combine the counts

Example: Join By Map-Reduce

- Compute the natural join $R(A,B) \bowtie S(B,C)$
- R and S are each stored in files
- Tuples are pairs (a,b) or (b,c)

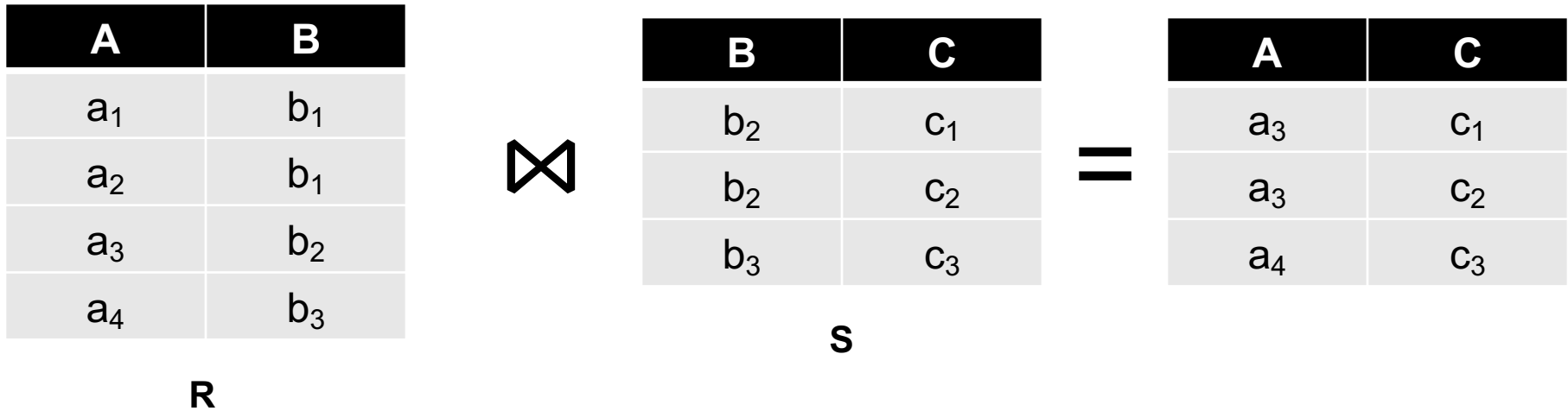

Example: A = user-id ; B = URL (webpage) visited by a user ; C = content type of the URL

Map-Reduce Join (Re-partition Join)

- Use a hash function h from **B-values** to $1\dots k$
- **A Map process turns:**
 - Each input tuple $R(a,b)$ into key-value pair $(b,(a,R))$
 - Each input tuple $S(b,c)$ into $(b,(c,S))$
- **Map processes** send each key-value pair with key b to Reduce process $h(b)$
 - Hadoop does this automatically; just tell it what k is.
- Each **Reduce process** matches all the pairs $(b,(a,R))$ with all $(b,(c,S))$ and outputs (a,b,c) .

Re-partition Join

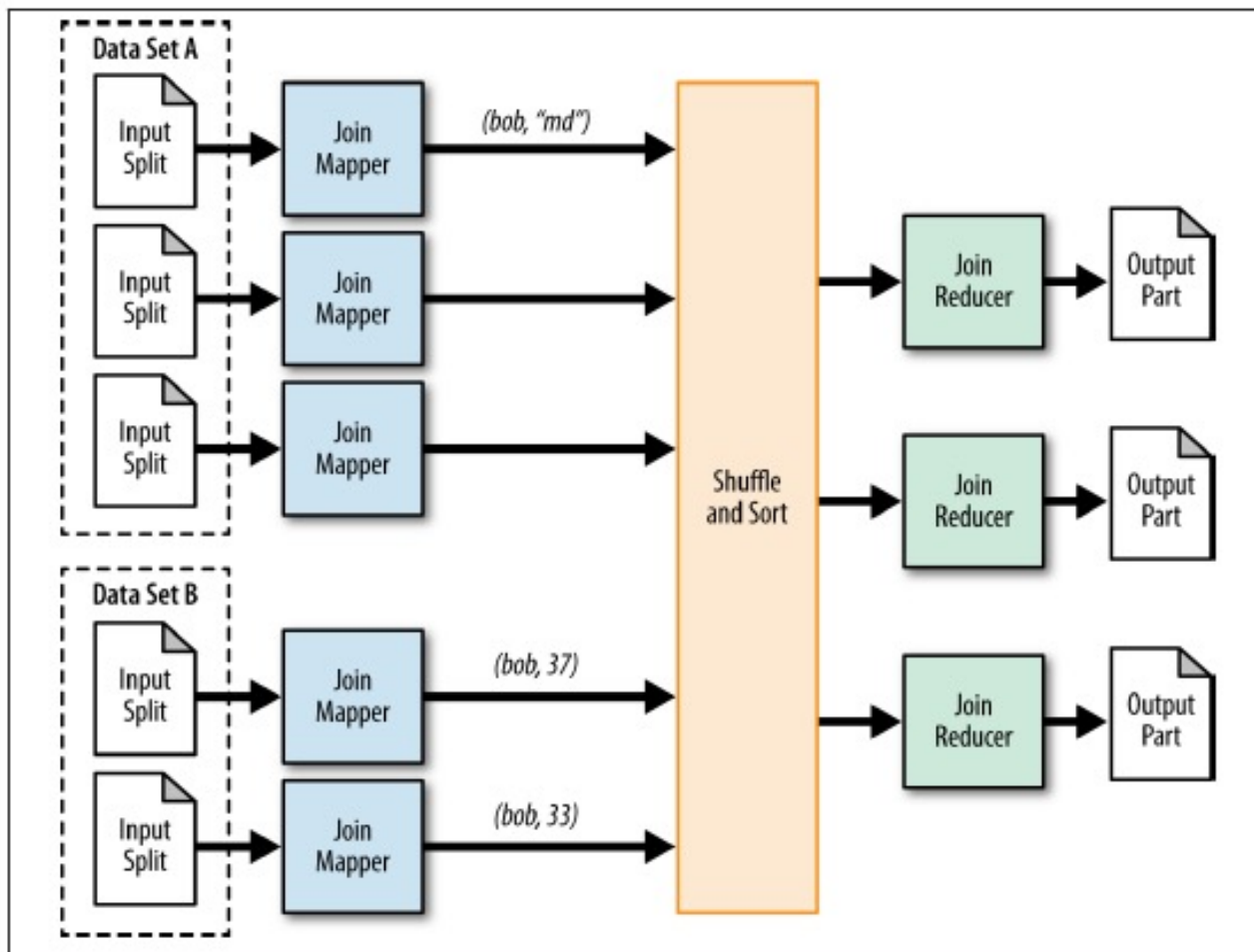

Replicated Join

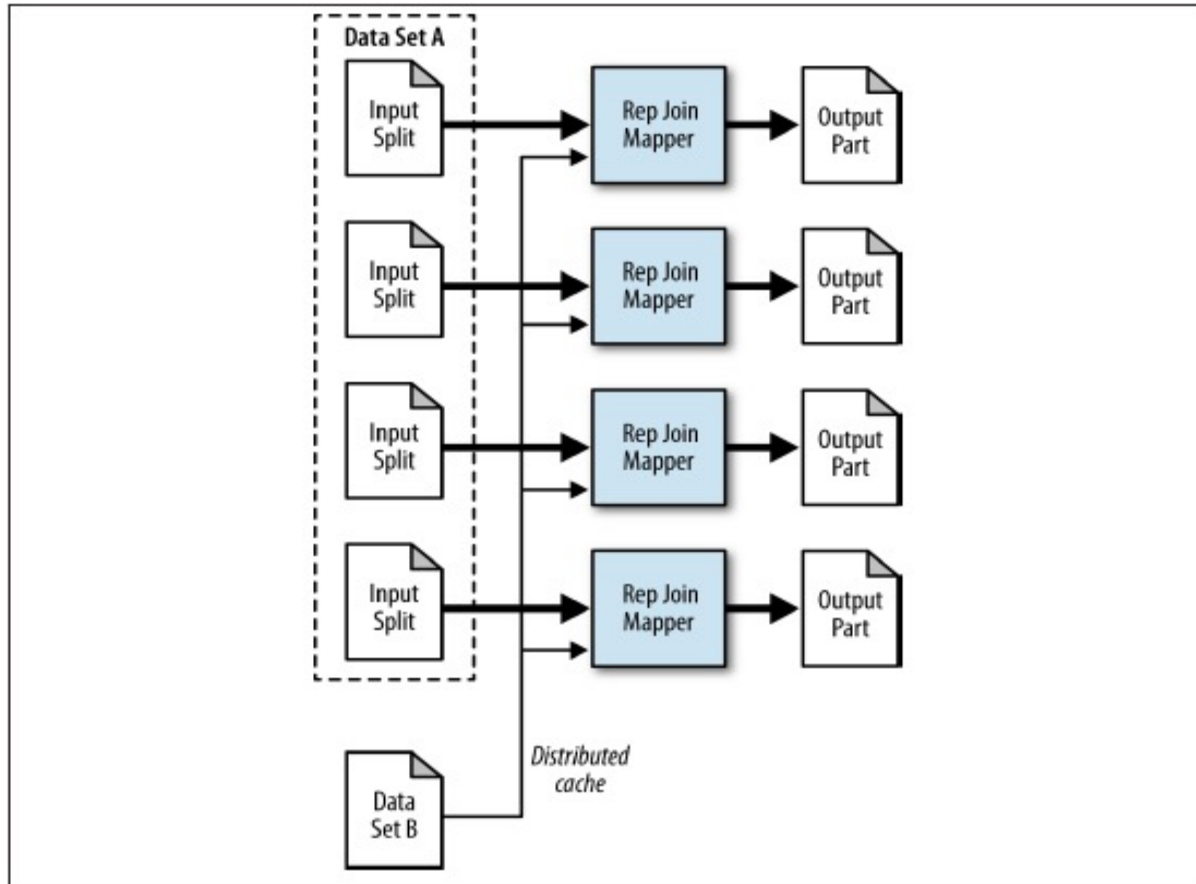

Composite Join

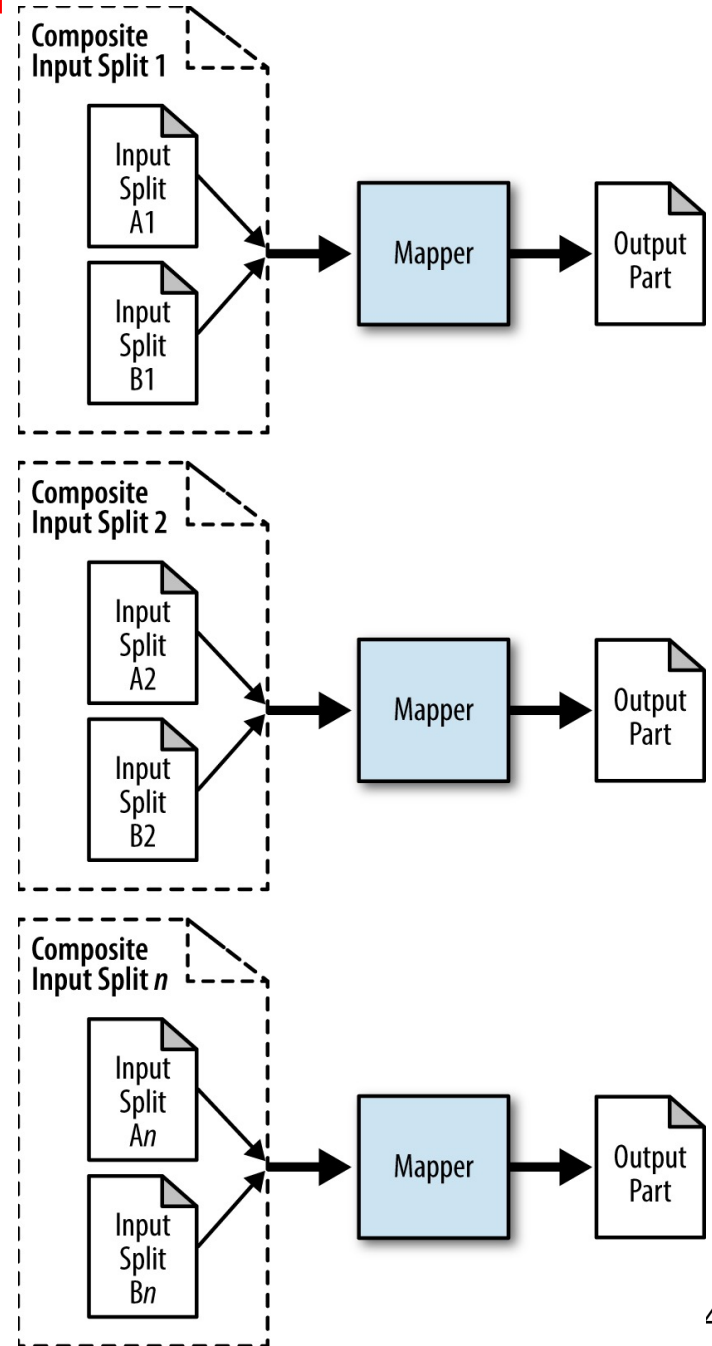
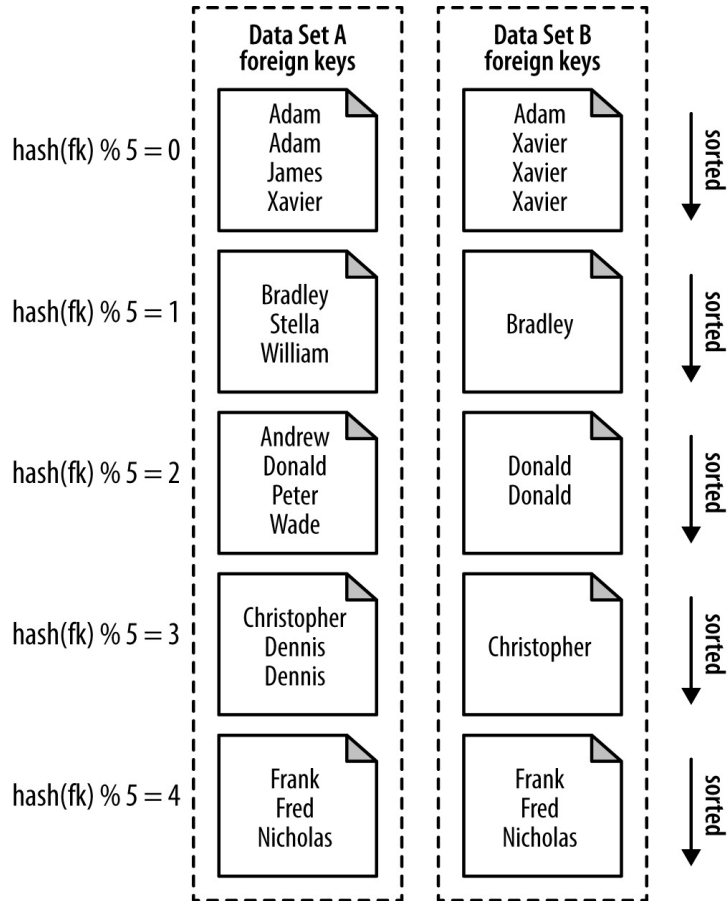

MapReduce can refer to...

- The programming model
- The execution framework (aka “runtime”)
- The specific implementation

Usage is usually clear from context!

MapReduce Implementations

- Google has a proprietary implementation in C++
 - Bindings in Java, Python
- Hadoop is an open-source implementation in Java
 - Development led by Yahoo, used in production
 - Now an Apache project
 - Rapidly expanding software ecosystem
- Lots of custom research implementations
 - For GPUs, cell processors, etc.

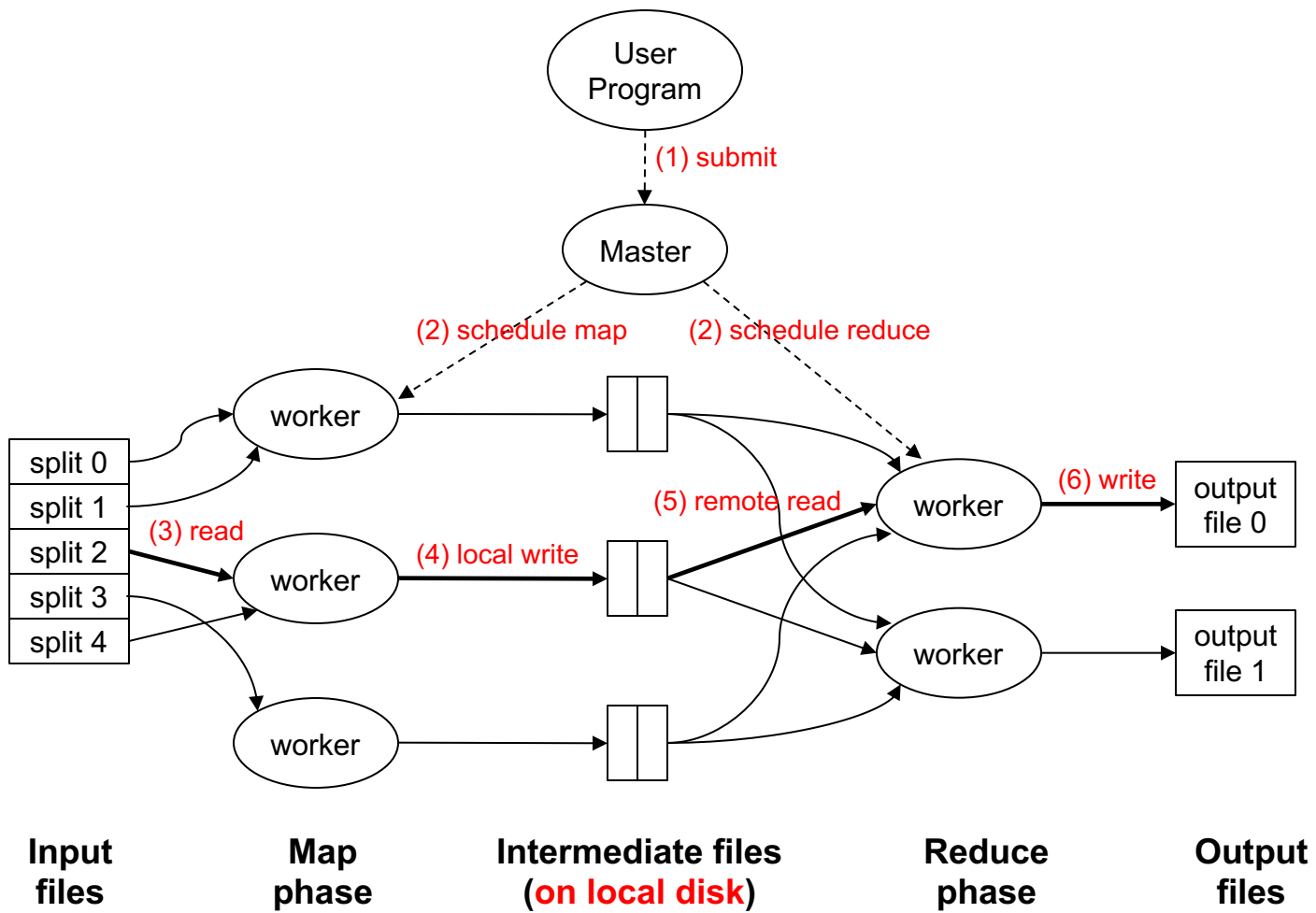

Data Flow

- **Input and final output are stored on a distributed file system (FS):**
 - Scheduler tries to schedule map tasks “close” to physical storage location of input data
- **Intermediate results are stored on local FS of Map and Reduce workers**
- **Output is often input to another MapReduce task**

Coordination: Master

- **Master node takes care of coordination:**
 - **Task status:** (idle, in-progress, completed)
 - **Idle tasks** get scheduled as workers become available
 - When a map task completes, it sends the master the location and sizes of its R intermediate files, one for each reducer
 - Master pushes this info to reducers
- Master pings workers periodically to detect failures

Dealing with Failures

○ Map worker failure

- Map tasks completed (Why ??) or in-progress at worker are reset to idle
- Reduce workers are notified when task is rescheduled on another worker

○ Reduce worker failure

- Only in-progress tasks are reset to idle
- Reduce task is restarted

○ Master failure

- MapReduce task is aborted and client is notified

How many Map and Reduce jobs?

- M map tasks, R reduce tasks
- **Rule of a thumb:**
 - Make M much larger than the number of nodes in the cluster
 - One DFS chunk (64 Mbyte each by default) per mapper is common
 - Improves dynamic load balancing and speeds up recovery from worker failures
- **Usually R is smaller than M**
 - Because output is spread across R files

Task Granularity & Pipelining

- **Fine granularity tasks:** # of map tasks \gg machines
 - Minimizes time for fault recovery
 - Can do pipeline shuffling with map execution
 - Better dynamic load balancing
 - e.g. For 2000 processors, $M = 200,000$; $R = 5000$

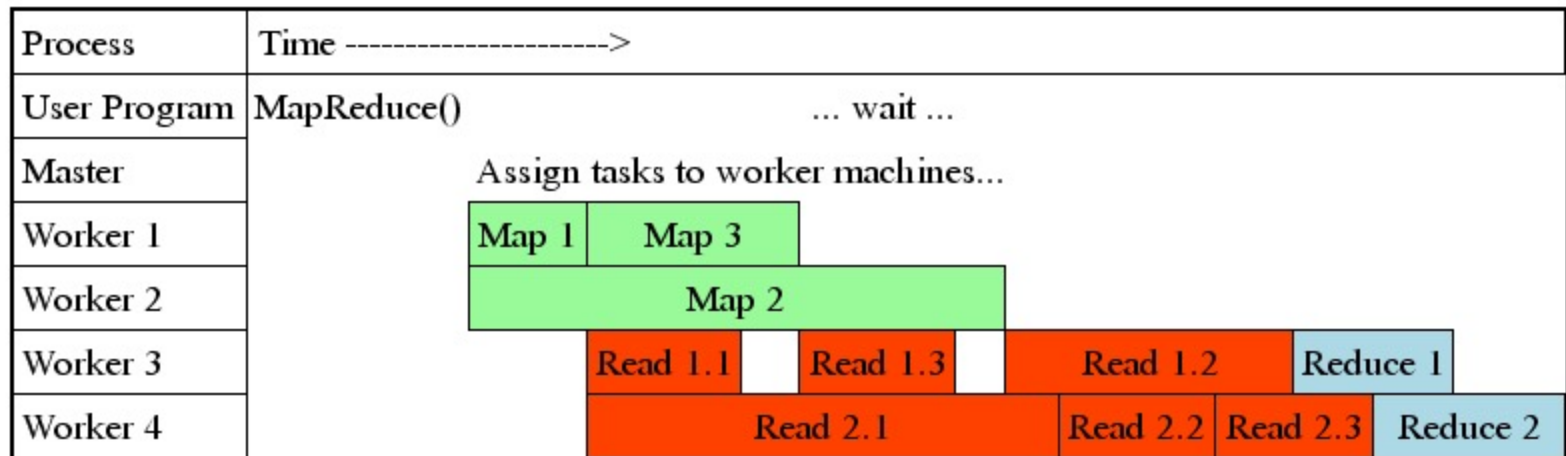

Refinements: Backup Tasks

○ Problem

- Slow workers, the so-called Stragglers, significantly lengthen the job completion time:
 - Other jobs on the machine
 - Bad disks
 - Weird things

○ Solution

- Near end of phase, spawn backup copies of tasks
 - Whichever one finishes first “wins”

○ Effect

- Dramatically shortens job completion time

How do we get data to the workers?

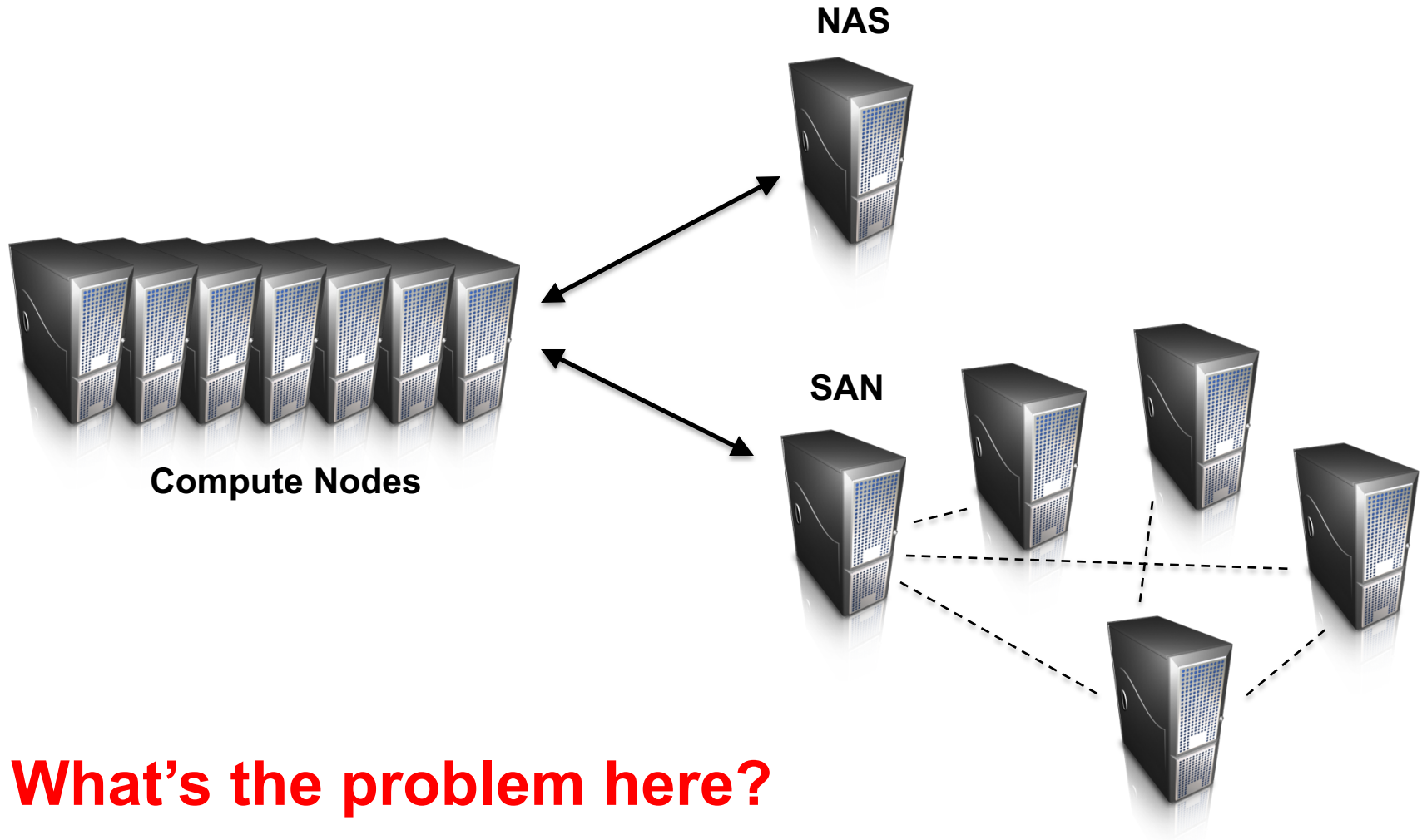

What's the problem here?

Distributed File System

- Don't move data to workers... move workers to the data!
 - Store data on the local disks of nodes in the cluster
 - Start up the workers on the node that has the data local
- Why?
 - Not enough RAM to hold all the data in memory
 - Disk access is slow, but disk throughput is reasonable
- A distributed file system is the answer
 - GFS (Google File System) for Google's MapReduce
 - HDFS (Hadoop Distributed File System) for Hadoop
 - Non-starters
 - Lustre (high bandwidth, but no replication outside racks)
 - Gluster (POSIX, more classical mirroring, see Lustre)
 - NFS/AFS/whatever - doesn't actually parallelize

GFS: Assumptions

- Commodity hardware over “exotic” hardware
 - Scale “out”, not “up”
- High component failure rates
 - Inexpensive commodity components fail all the time
- “Modest” number of huge files
 - Multi-gigabyte files are common, if not encouraged
- Files are write-once, mostly appended to
 - Perhaps concurrently
- Large streaming reads over random access
 - High sustained throughput over low latency

GFS: Design Decisions

- Files stored as chunks
 - Fixed size (64MB)
- Reliability through replication
 - Each chunk replicated across 3+ chunkservers
- Single master to coordinate access, keep metadata
 - Simple centralized management
- No data caching
 - Little benefit due to large datasets, streaming reads
- Simplify the API
 - Push some of the issues onto the client (e.g., data layout)

HDFS = GFS clone (same basic ideas)

Google File System

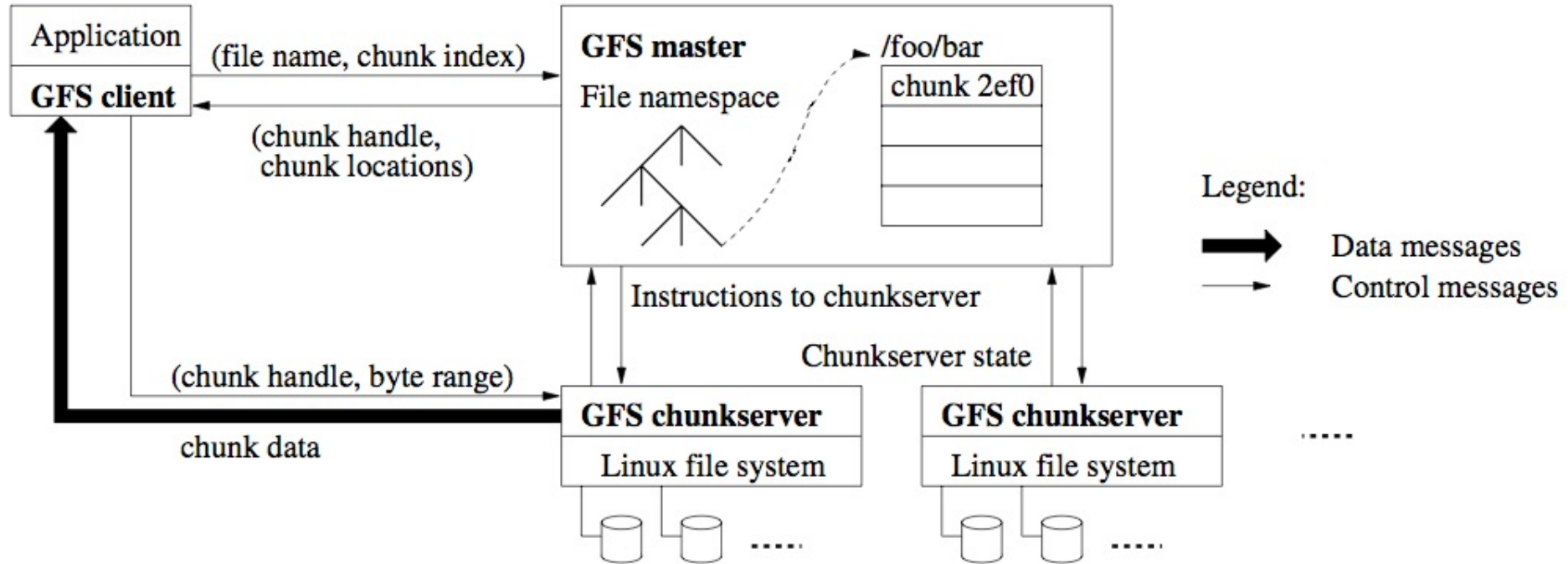

Ghemawat, Gobiuff, Leung, 2003

- Chunk servers hold blocks of the file (64MB per chunk)
- Replicate chunks (chunk servers do this autonomously). **More bandwidth and fault tolerance**
- **Master distributes, checks faults, rebalances (Achilles heel)**
- Client can do bulk read / write / random reads

Google File System /HDFS

1. Client requests chunk from master
2. Master responds with replica location
3. Client writes to replica A
4. Client notifies primary replica
5. Primary replica requests data from replica A
6. Replica A sends data to Primary replica (same process for replica B)
7. Primary replica confirms write to client

- Master ensures nodes are live
- **Chunks are checksummed**
- **Can control replication factor for hotspots / load balancing**
- **Deserialize master state by loading data structure as flat file from disk (fast)** ; See Section 4.1 of GFS SOSP2003 paper for details

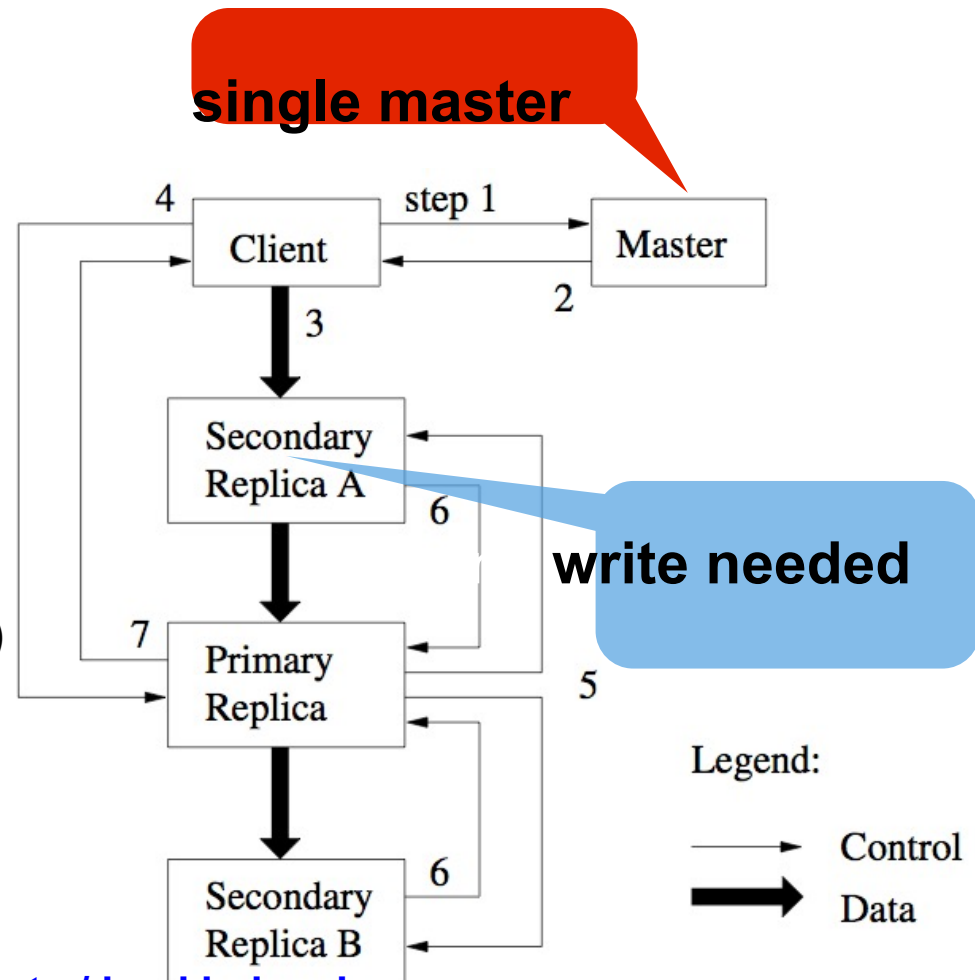

Design Options of the Data Structure for a Filesystem

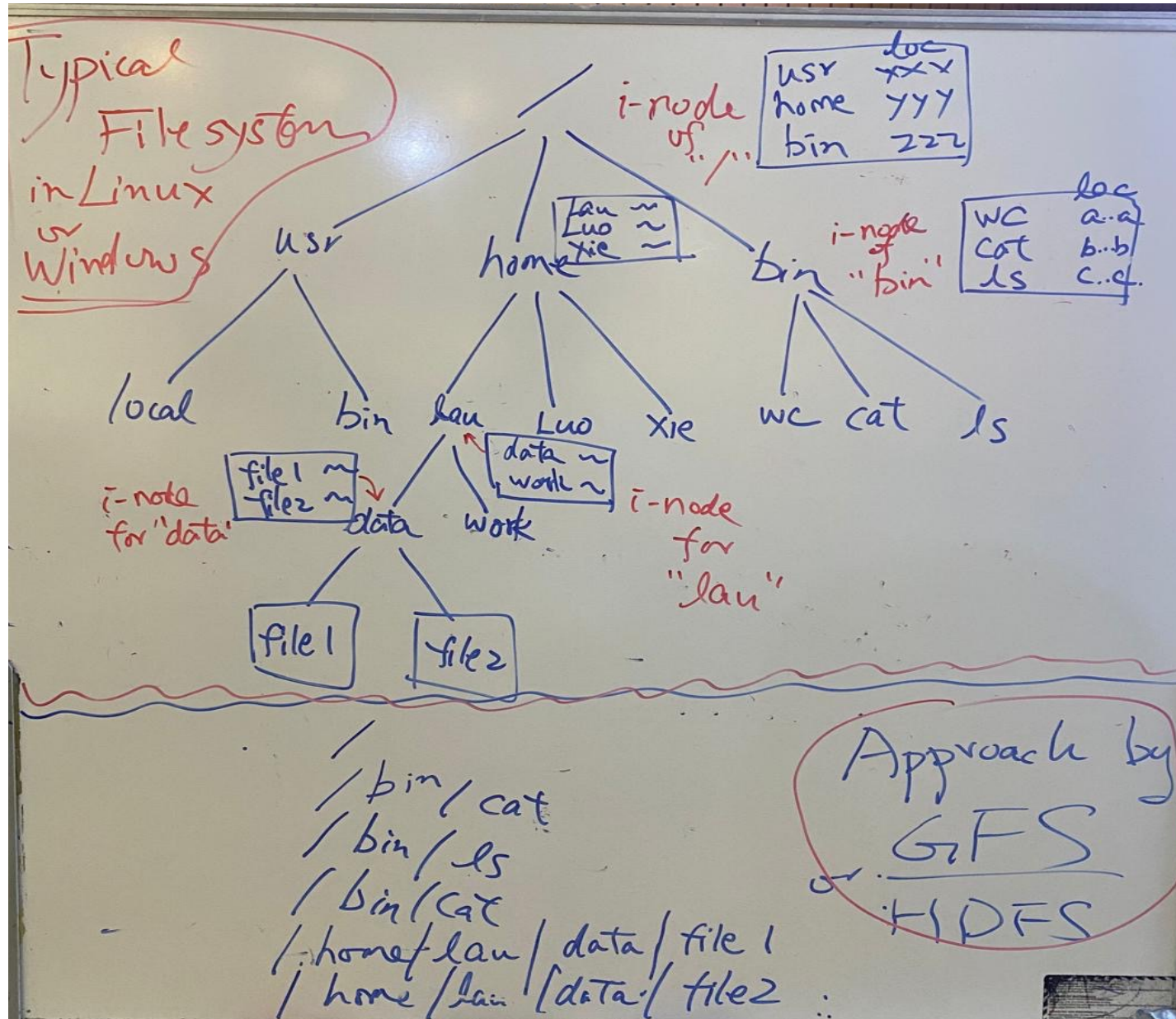

From GFS to HDFS

- Terminology differences:
 - GFS master = Hadoop namenode
 - GFS chunkservers = Hadoop datanodes
- Functional differences:
 - Initially, no file appends in HDFS (the feature has been added recently)
 - <http://blog.cloudera.com/blog/2009/07/file-appends-in-hdfs/>
 - <http://blog.cloudera.com/blog/2012/01/an-update-on-apache-hadoop-1-0/>
 - HDFS performance is (likely) slower

For the most part, we'll use the Hadoop terminology...

HDFS Architecture

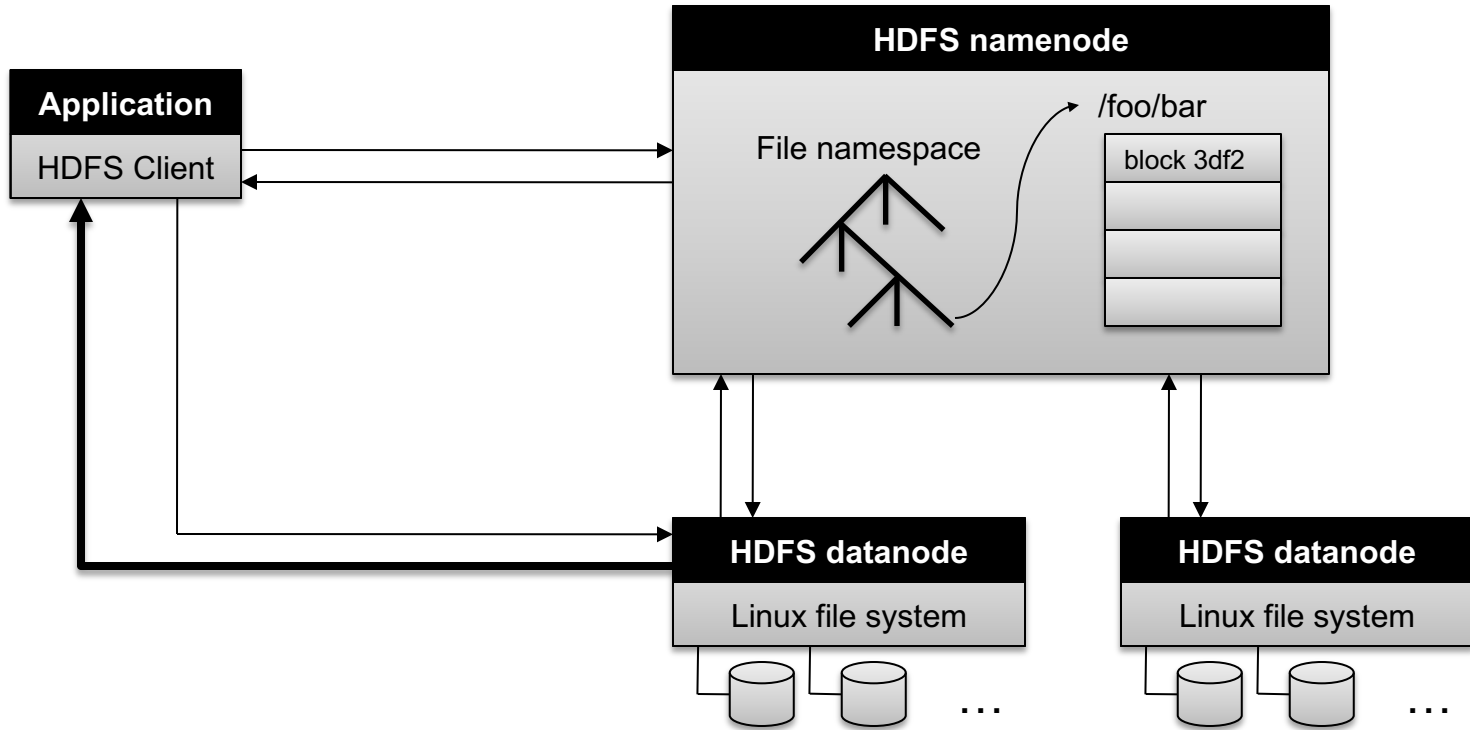

Namenode Responsibilities

- Managing the file system namespace:
 - Holds file/directory structure, metadata, file-to-block mapping, access permissions, etc.
- Coordinating file operations:
 - Directs clients to datanodes for reads and writes
 - No data is moved through the namenode
- Maintaining overall health:
 - Periodic communication with the datanodes
 - Block re-replication and rebalancing
 - Garbage collection
- Namenode can be Archille's heel – Single point of failure or bottleneck of scalability for the entire FS:
 - Need to have a Backup Namenode HDFS (or Master in GFS)
 - Compared to the fully-distributed approach in Ceph

Putting everything together...

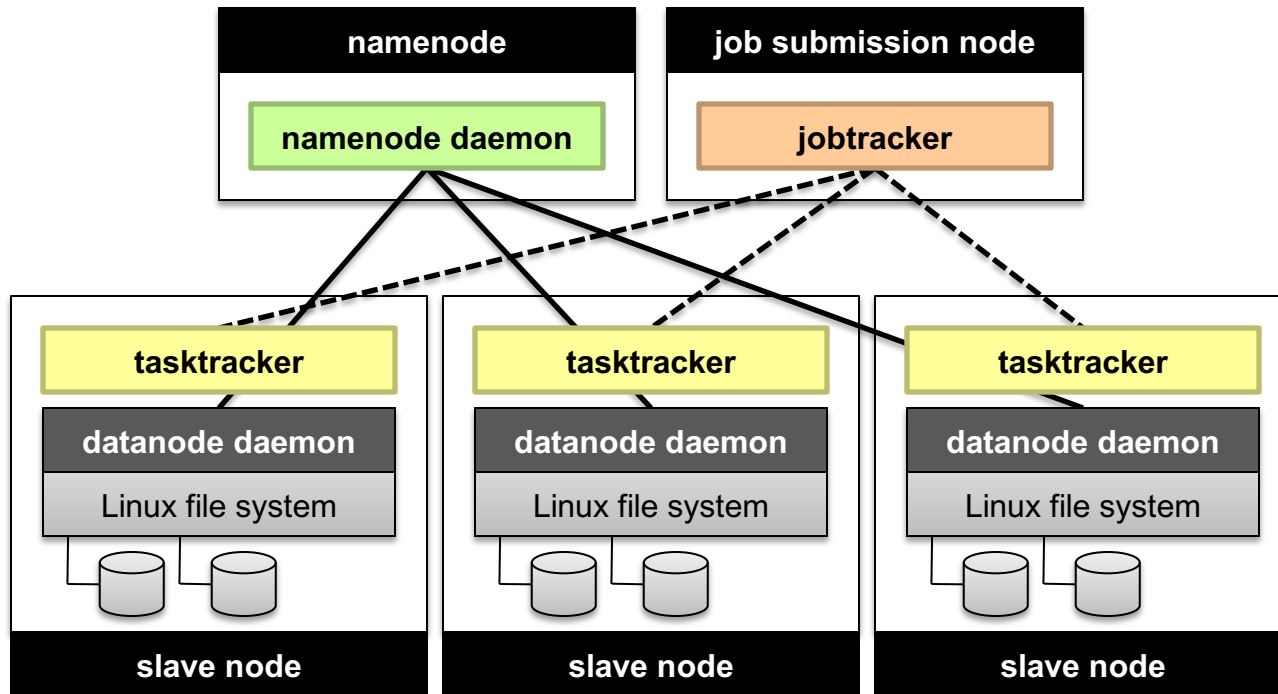

MapReduce is good for...

- *Embarrassingly Parallel* algorithms
- Summing, grouping, filtering, joining
- Off-line batch jobs on massive data sets
- Analyzing an entire large data set
 - New higher level languages/systems have been developed to further simplify data processing using MapReduce
 - Declarative description (NoSQL type) of processing task can be translated automatically to MapReduce functions
 - Control flow of processing steps (Pig)

MapReduce is OK, (and only ok) for...

- Iterative jobs (e.g. Graph algorithms like Pagerank)
 - Each iteration must read/write data to disk
 - I/O and latency cost of an iteration is high

MapReduce is NOT good for...

- Jobs that need shared state/ coordination
 - Tasks are shared-nothing
 - Shared-state requires scalable state store
- Low-latency jobs
- Jobs on small datasets
- Finding individual records

For some of these, we will introduce alternative computational models/ platforms, e.g. GraphLab, Spark, later in the course

Practical Limits of Hadoop1.0

- ❖ Scalability
 - ❖ Maximum Cluster Size – 4000 Nodes
 - ❖ Maximum Concurrent Tasks – 40000
 - ❖ Coarse synchronization in Job Tracker
- ❖ Single point of failure
 - ❖ Failure kills all queued and running jobs
 - ❖ Jobs need to be resubmitted by users
- ❖ Restart is very tricky due to complex state

Scalability/Flexibility Issues of the MapReduce/ Hadoop 1.0 Job Scheduling/Tracking

- The MapReduce Master node (or Job-tracker in Hadoop 1.0) is responsible to monitor the progress of ALL tasks of all jobs in the system and launch backup/replacement copies in case of failures
 - For a large cluster with many machines, the number of tasks to be tracked can be huge
 - => Master/Job-Tracker node can become the performance bottleneck
- Hadoop 1.0 platform focuses on supporting MapReduce as its only computational model ; may not fit all applications
- Hadoop 2.0 introduces a new resource management/ job-tracking architecture, YARN [1], to address these problems

[1] V.K. Vavilapalli, A.C.Murthy, “Apache Hadoop YARN: Yet Another Resource Negotiator,” ACM Symposium on Cloud Computing 2013.

YARN for Hadoop 2.0

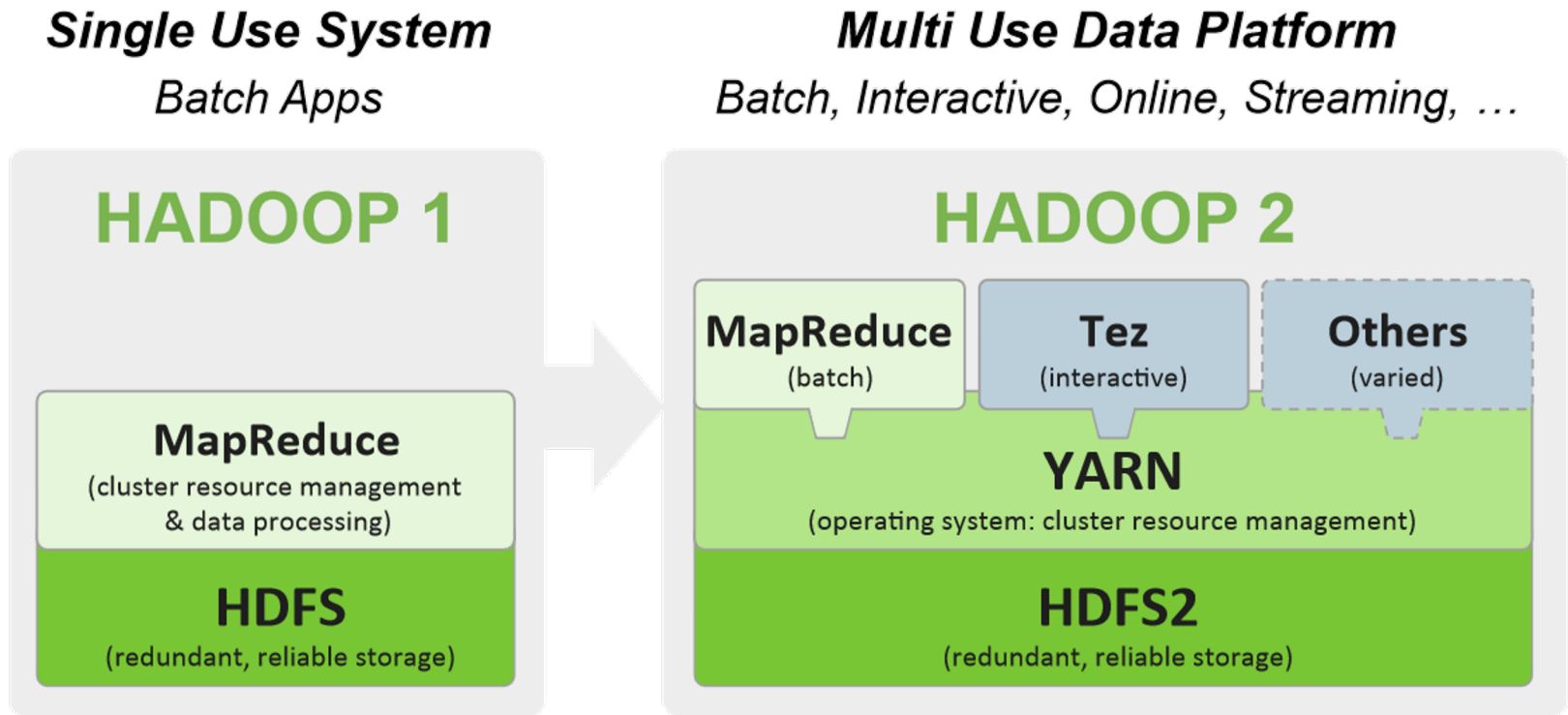

- **YARN (Yet Another Resource Negotiator)** provides a resource management platform for Cluster to support general Distributed/Parallel Applications/Frameworks beyond the MapReduce computational model.

V. K. Vavilapalli, A. C. Murthy, “Apache Hadoop YARN: Yet Another Resource Negotiator”, in ACM Symposium on Cloud Computing (SoCC) 2013.

A Big Data Processing Stack with YARN (more later)

Applications Run Natively **IN** Hadoop



YARN for Hadoop 2.0

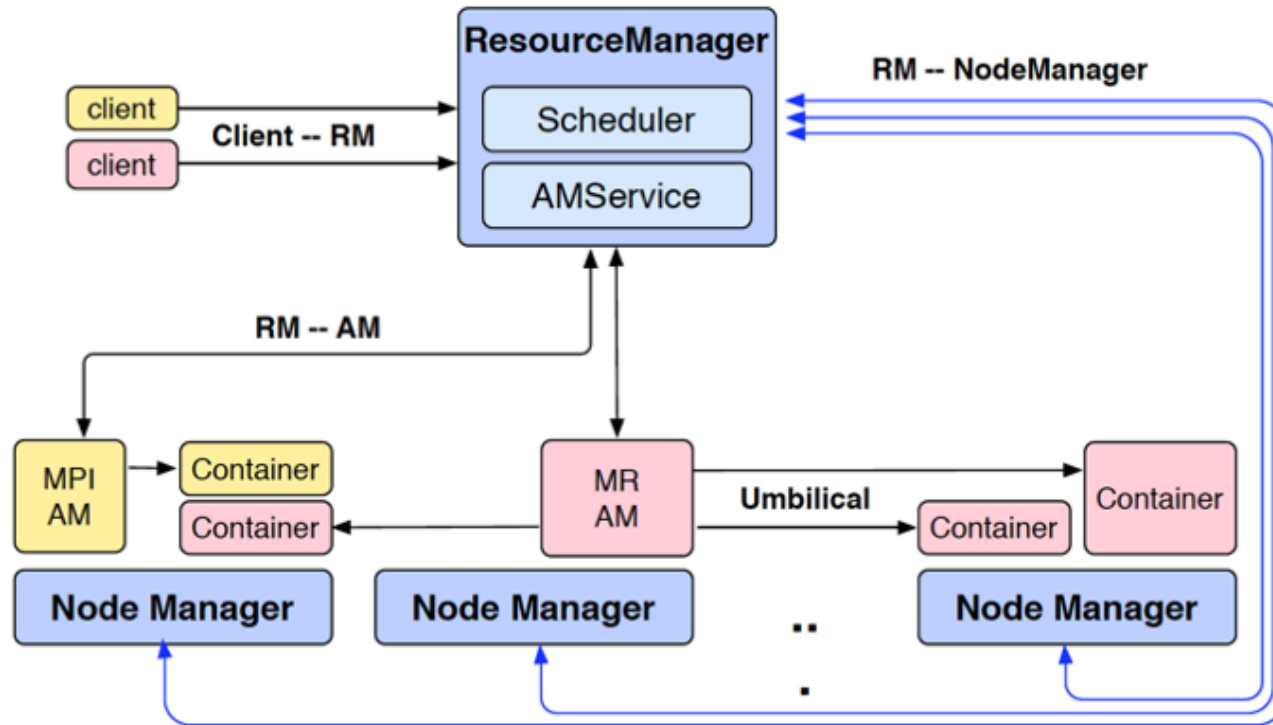

- Multiple frameworks (Applications) can run on top of YARN to share a Cluster, e.g. MapReduce is one framework (Application), MPI, or Storm are other ones.
- YARN splits the functions of JobTracker into 2 components: **resource allocation** and **job-management (e.g. task-tracking/ recovery)**:
 - Upon launching, each Application will have its own Application Master (AM), e.g. MR-AM in the figure above is the AM for MapReduce, to track its own tasks and perform failure recovery if needed
 - Each AM will request resources from the YARN Resource Manager (RM) to launch the Application's jobs/tasks (Containers in the figure above) ;
 - The YARN RM determines resource allocation across the entire cluster by communicating with/controlling the Node Managers (NM), one NM per each machine.

Besides the Computational Model:

Typical Architecture for Big Data Processing Systems

Typical Architecture of Cloud Computing/ Big Data Processing Systems

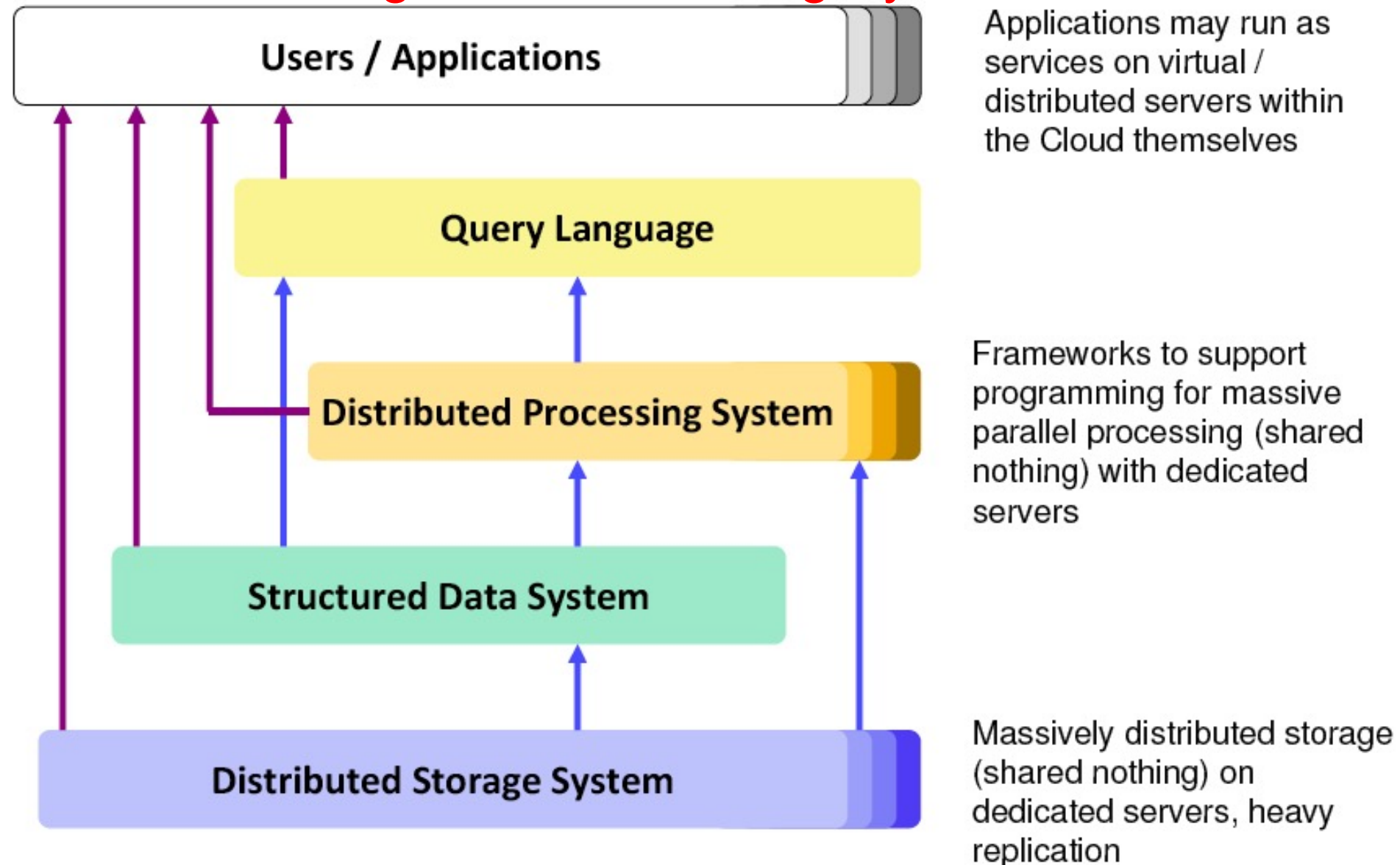

Typical Architecture: Different Component Systems for various Services and Functionalities

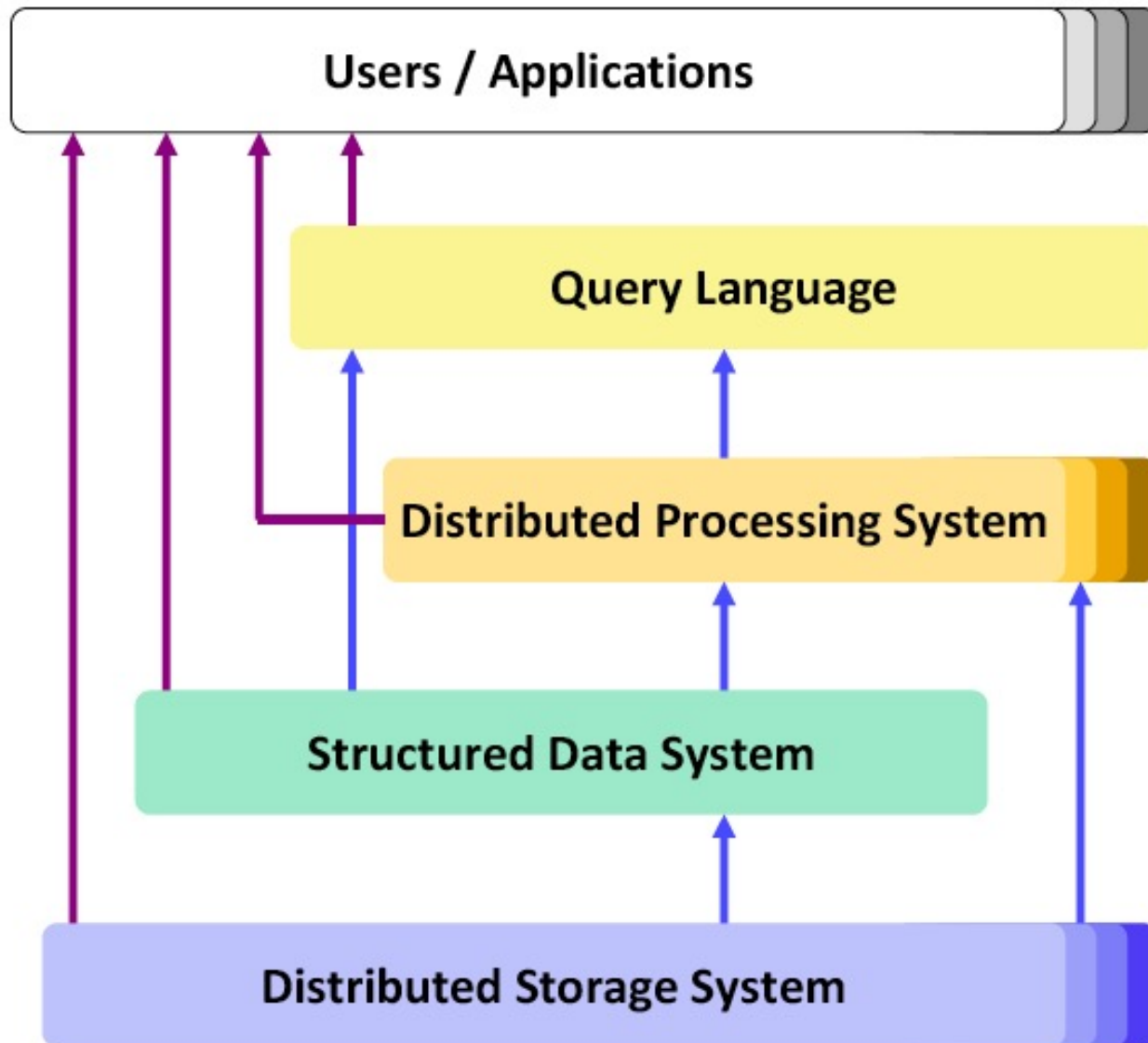

High-level language for accessing data and controlling processing, but typically not SQL!

Performance for complex operations (SQL-style joins and grouping, data analysis, etc.)

Simple but flexible data model (mostly key/value pairs), basic access operations (lookup-API)

Performance for data accesses, fault-tolerance, availability, scalability

Typical Architecture: Different Component Systems for various Services and Functionalities

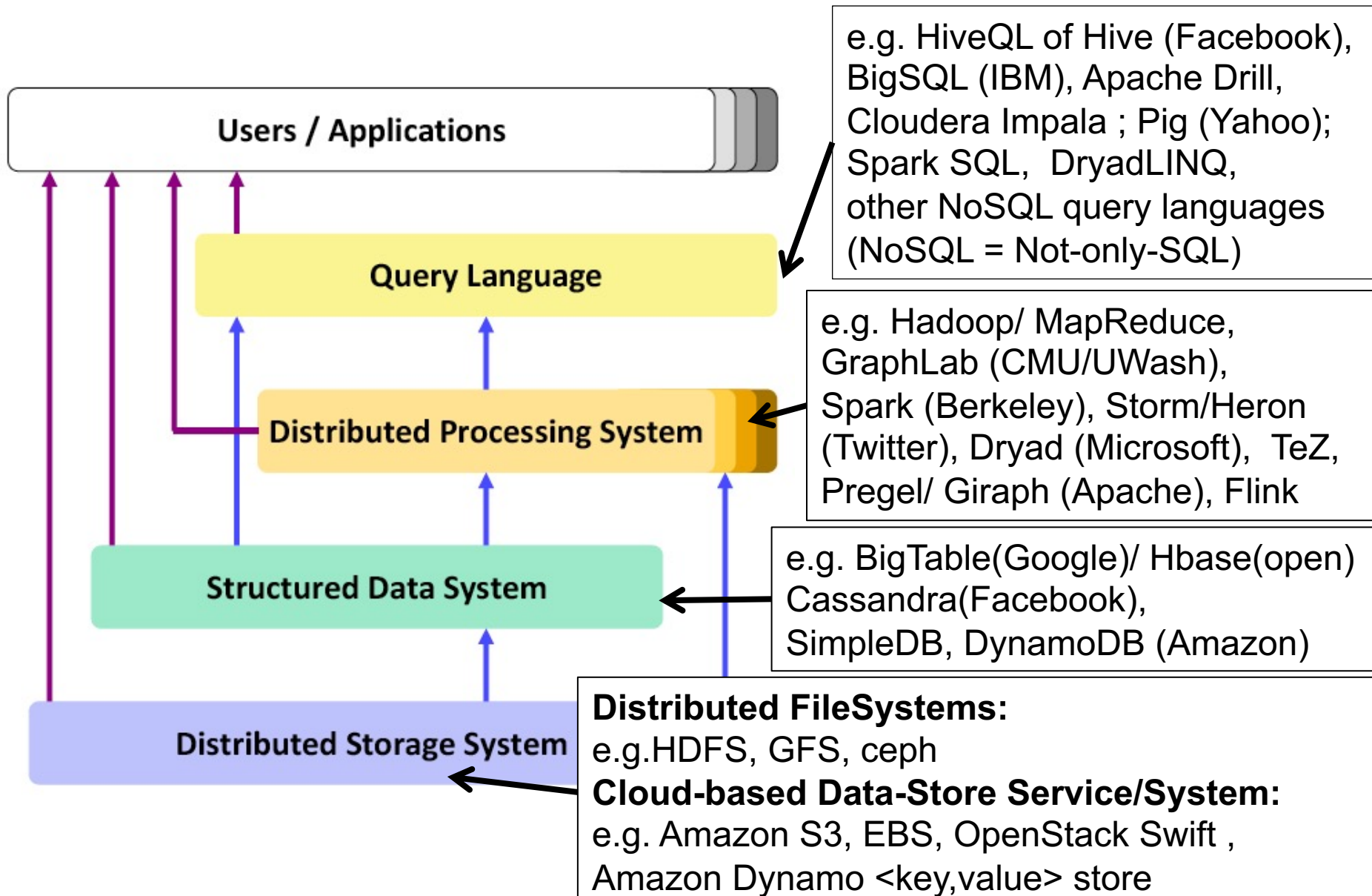

Architecture Sample 1: The Google-way (circa ~2002)

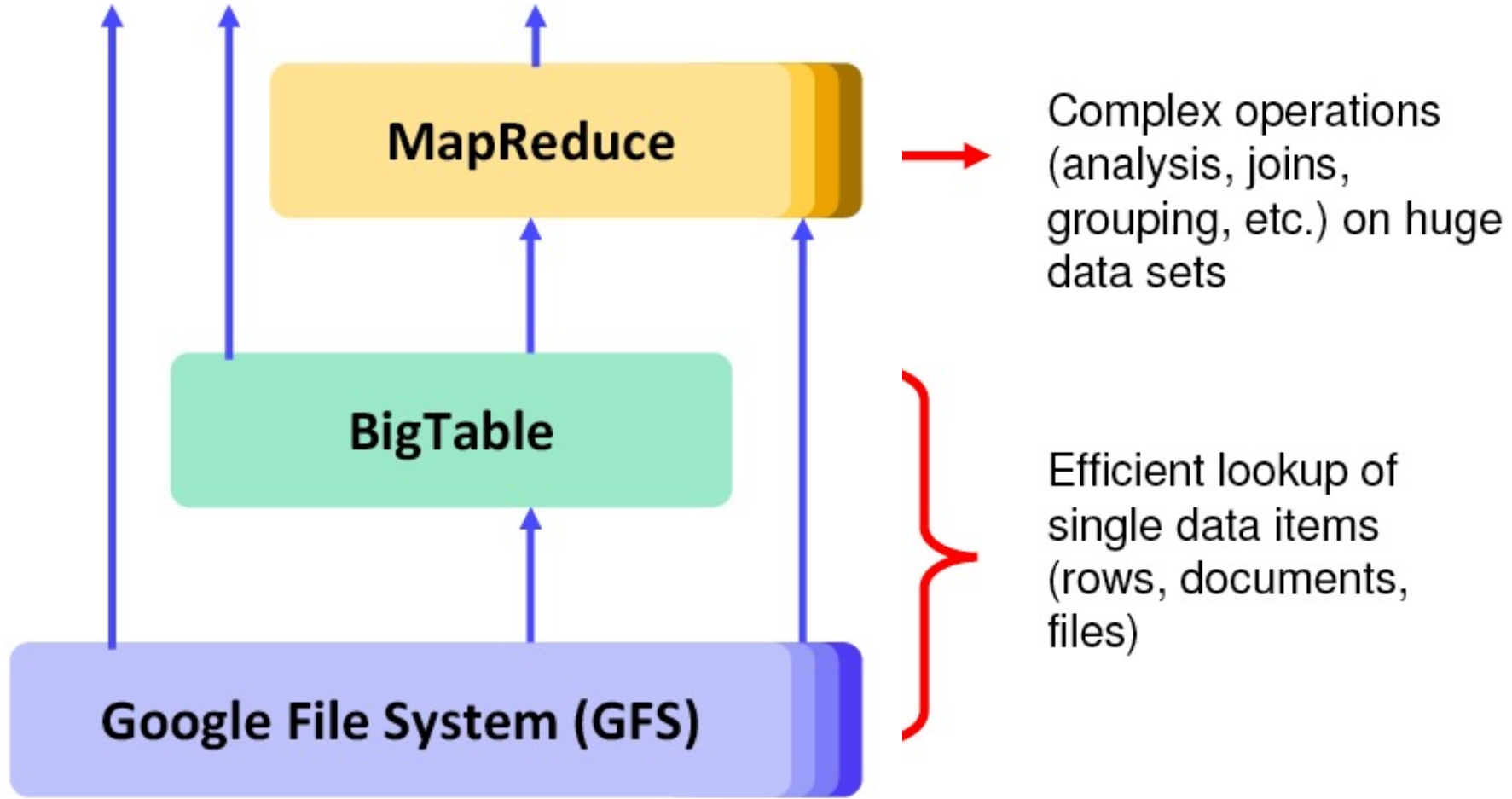

Google's BigTable

- Fast and Large-scale (PB range) Database Management System (DBMS) for Google applications and services
- Data Model = Sparse, Distributed Multi-dimensional Sorted Map,
 - Think of it as a Distributed, Super-Large Spreadsheet split over a huge cluster of servers
 - Adjacent rows grouped to form a Tablet, which is hosted in the same server
 - Row range for each Tablet is dynamically partitioned for Load-balancing
 - Read/Write under a single Row key are atomic
- Distributed, persistent lock/ name service from Chubby
- Rely on GFS to store data and logs
- Commonly used as Data Input source and Output target for MapReduce programs ;

BigTable Data Model

Row key	Contents:	Anchor:	Language:	
"com.google.www"	"<html> ... </html>" t_1	inria.fr	"english" t_1	
		"google.com" t_2		
		"Google" t_3		
	"<html> ... </html>" t_5	uwaterloo.ca		
		"google.com" t_4		

Fig. 18.7 Example of a Bigtable Row

From [ÖzsuValduriez2011]

More detailed coverage on BigTable in the IERG4330 course !

Google Applications using BigTable

- Google Maps
- Google Book Search
- Google Earth
- Google Analytics
- Blogger.com
- YouTube
- Gmail
- ...

Google Applications using BigTable (cont'd)

Project name	Table size (TB)	Compression ratio	# Cells (billions)	# Column Families	# Locality Groups	% in memory	Latency-sensitive?
<i>Crawl</i>	800	11%	1000	16	8	0%	No
<i>Crawl</i>	50	33%	200	2	2	0%	No
<i>Google Analytics</i>	20	29%	10	1	1	0%	Yes
<i>Google Analytics</i>	200	14%	80	1	1	0%	Yes
<i>Google Base</i>	2	31%	10	29	3	15%	Yes
<i>Google Earth</i>	0.5	64%	8	7	2	33%	Yes
<i>Google Earth</i>	70	–	9	8	3	0%	No
<i>Orkut</i>	9	–	0.9	8	5	1%	Yes
<i>Personalized Search</i>	4	47%	6	93	11	5%	Yes

Table 2: Characteristics of a few tables in production use. *Table size* (measured before compression) and *# Cells* indicate approximate sizes. *Compression ratio* is not given for tables that have compression disabled.

From [F. Chang et al.: Bigtable: A Distributed Storage System for Structured Data, OSDI 2006]

Architecture Sample 2: The Hadoop-way (e.g. Yahoo circa ~ 2008)

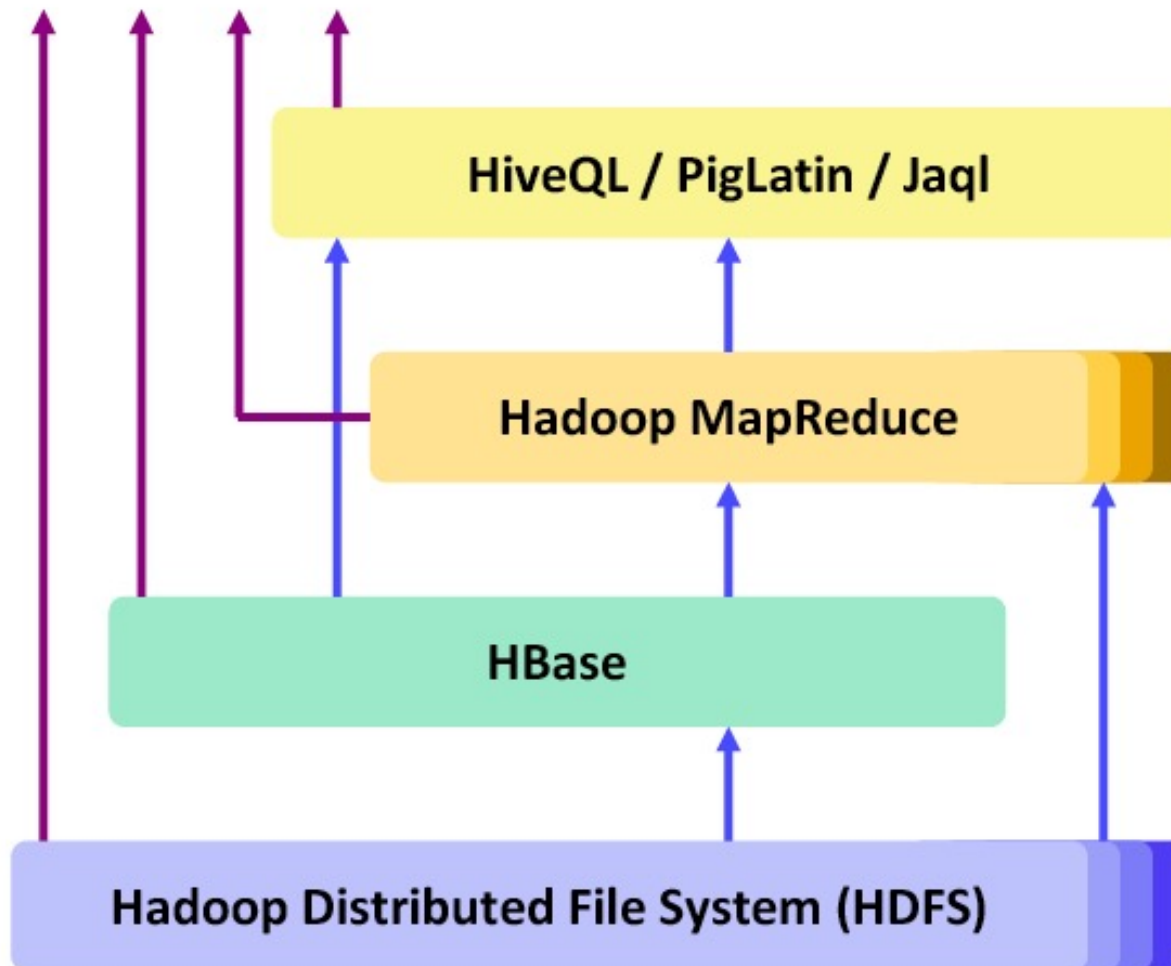

Hadoop 1.0 vs. Hadoop 2.0 Ecosystem

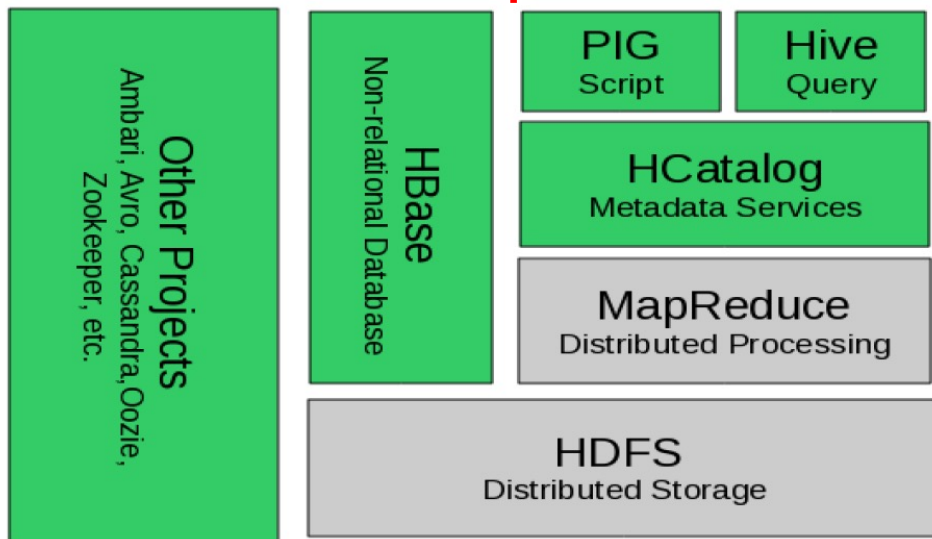

Figure 2.1 The Hadoop 1.0 ecosystem, MapReduce and HDFS are the core components, while other are built around the core.

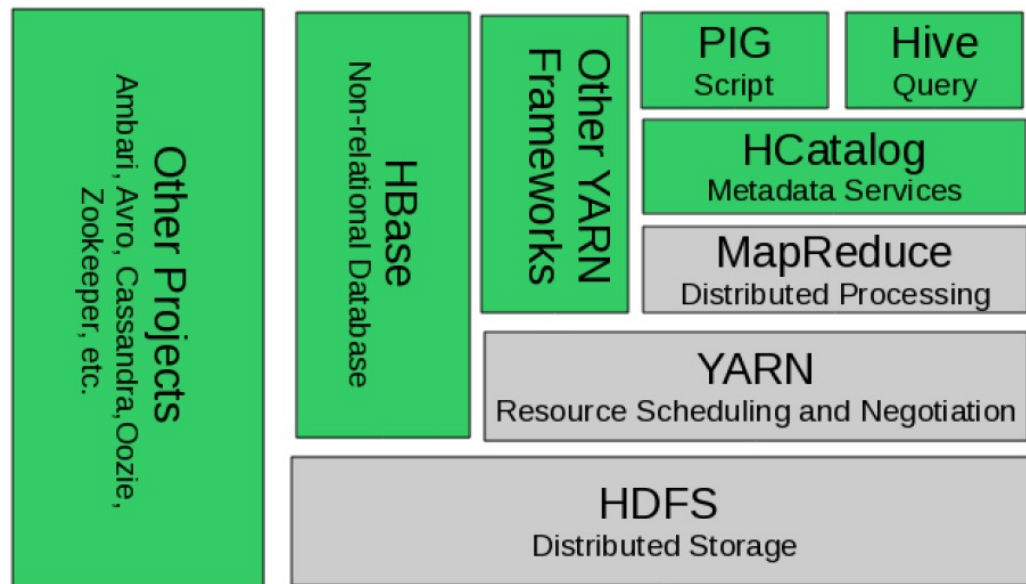

Figure 2.2 YARN adds a more general interface to run non-MapReduce jobs within the Hadoop framework

HBase

- Can be considered as the **Open-source** version of BigTable
- Semi-**structured** data storage
- Developed initially by Powerset (an NLP company)
- Now part of Apache's (open-source) Hadoop project
 - Like BigTable, HBase tables can serve as Data input/output store for MapReduce jobs run in Hadoop
 - Based on HDFS
- Access via Java API, REST and others
- Used by, e.g. Facebook's Messaging Platform

Apache Cassandra

- BigTable data model running on an Amazon Dynamo-like (P2P) infrastructure
- Developed initially by Facebook
- Now part of Apache Software Foundation (Open-source)
- Differences w.r.t. Hbase
 - Standalone system
 - Not based on HDFS
 - Storage approach similar to Distributed Hash Table (DHT)
 - Tunable consistency levels

Apache Hive

- Data warehouse infrastructure built on top of Hadoop
- Initially developed by Facebook
- Now part of Apache Software Foundation (Open-source)
- Use to analyze large datasets stored in
 - HDFS
 - Amazon S3
- Support SQL-like query language called HiveSQL

Beyond Hadoop/MapReduce:

Another Main-stream Big Data Processing Framework

- o Spark & Berkeley Data Analytic Stack (BDAS) by UC Berkeley

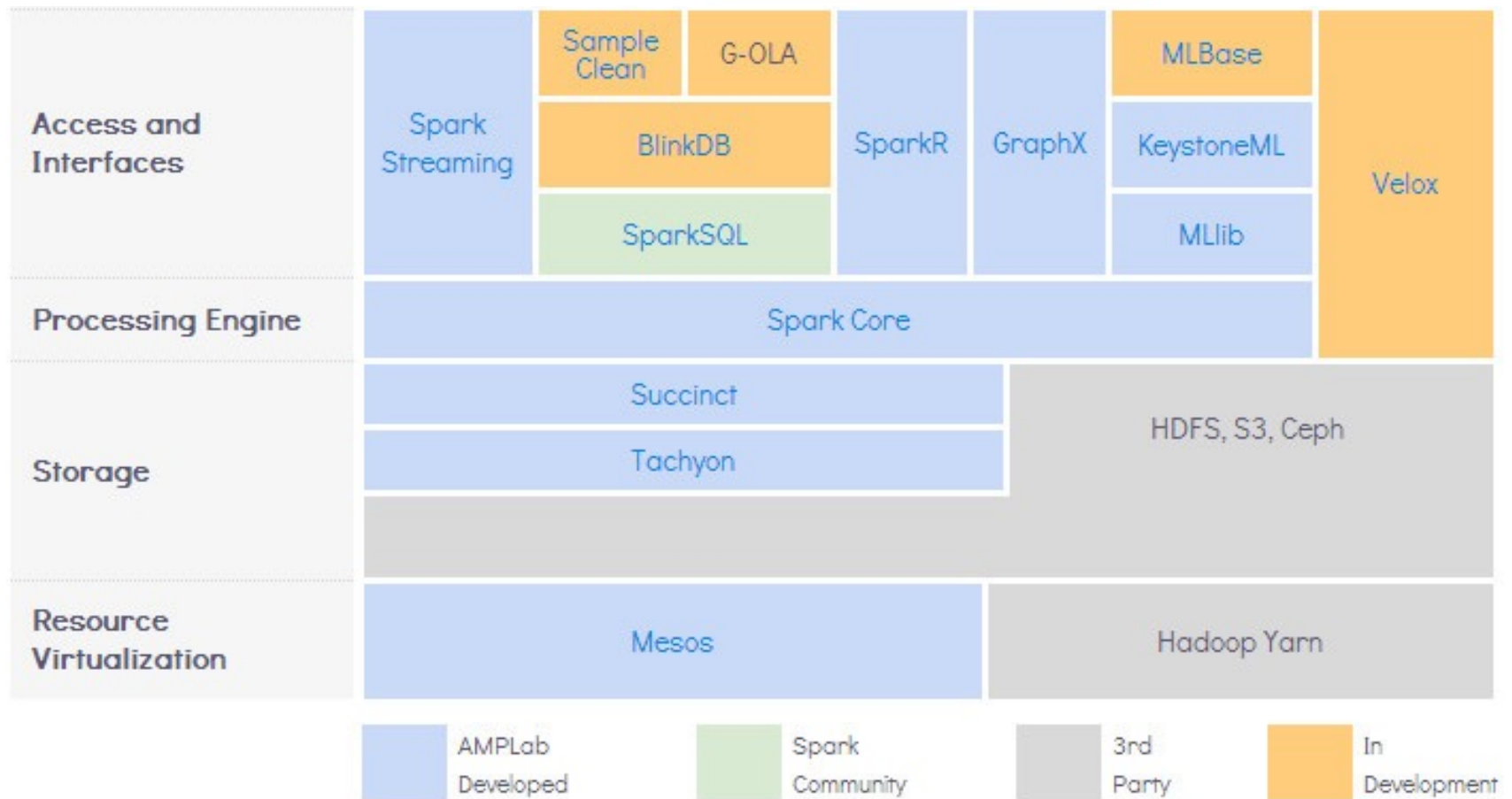

Reference: <https://amplab.cs.berkeley.edu/software/>

Alternative: Relational Database Management System (RDMS) as a Service

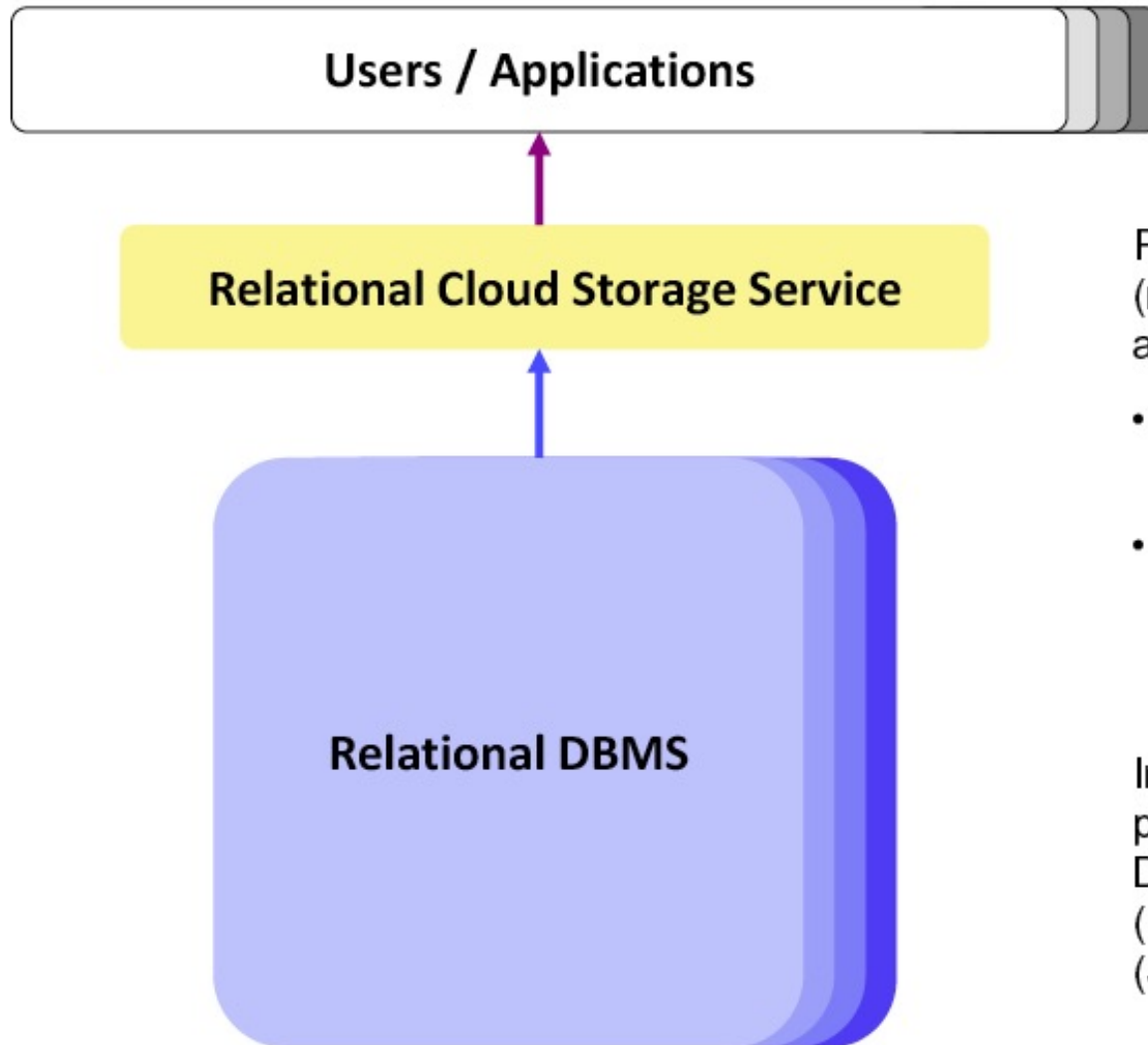

Relational Model and SQL (maybe with restrictions) as a service, e.g.

- **Amazon Relational Database Service (RDS)**
- **Microsoft SQL Azure**

Implemented on top of parallel clusters of common DBMS Servers, e.g. MySQL (RDS) or MS SQL Server (SQL Azure)

MapReduce vs. Parallel RDBMS

○ MapReduce

- + Very Scalable, Fault-tolerant and Automatic Load-balancing
- + Operates well in Heterogeneous Clusters
- Writing Map/Reduce jobs is more complicated than writing SQL queries
- Performance largely depends on the skill of the programmer

○ Parallel RDBMS

- + Usually very good and consistent performance
- + Flexible and proven interface (SQL)
- + SQL-queries are automatically optimized for transaction performance
- Scaling is rather Limited (10's of nodes)
- Does NOT work well in Heterogeneous Clusters
- Not very Fault-Tolerant

MapReduce vs. Parallel RDBMS

	Parallel DBMS	MapReduce
Schema Support	<input checked="" type="checkbox"/>	<input checked="" type="checkbox"/>
Indexing	<input checked="" type="checkbox"/>	<input checked="" type="checkbox"/>
Programming Model	Stating what you want (declarative: SQL)	Presenting an algorithm (procedural: C/C++, Java, ...)
Optimization	<input checked="" type="checkbox"/>	<input checked="" type="checkbox"/>
Scaling	1 – 500	10 - 5000
Fault Tolerance	Limited	Good
Execution	Pipelines results between operators	Materializes results between phases

SQL vs. MapReduce

- Selection / projection / aggregation

- SQL Query:

```
SELECT year, SUM(price)
FROM sales
WHERE area_code = "US"
GROUP BY year
```

- Map/Reduce job:

```
map(key, tuple) {
    int year = YEAR(tuple.date);
    if (tuple.area_code = "US")
        emit(year, {'year' => year, 'price' => tuple.price });
}
```

```
reduce(key, tuples) {
    double sum_price = 0;
    foreach (tuple in tuples) {
        sum_price += tuple.price;
    }
    emit(key, sum_price);
}
```

SQL vs. MapReduce (cont'd)

- **Sorting**

- SQL Query:

```
SELECT *  
FROM sales  
ORDER BY year
```

- Map/Reduce job:

```
map(key, tuple) {  
    emit(YEAR(tuple.date) DIV 10, tuple);  
}
```

```
reduce(key, tuples) {  
    emit(key, sort(tuples));  
}
```

NoSQL (Not-only SQL) vs. RDBMS

- RDBMS provides **too much**:
 - ACID (Atomicity, Consistency, Isolation, Durability) transactions
 - Complex Query Language
 - Lots and lots of knobs to turn
- RDBMS provides **too little**:
 - Lack of (cost-effective) scalability, availability
 - Not enough schema/data-type flexibility
- NoSQL
 - Lots of optimization and tuning possible for Analytics
 - Flexible programming model
- NoSQL can borrow many good ideas from RDBMS
 - Declarative Language
 - Parallelization and Optimization Techniques
 - Value of Data Consistency

Recap

- MapReduce – A Computational Model for Big Data Processing
- The MapReduce Runtime, GFS/ HDFS
- Sample Applications for MapReduce
- Typical Architectures for Big Data Processing Systems

Further Reading

- Jeffrey Dean and Sanjay Ghemawat: MapReduce: Simplified Data Processing on Large Clusters
<http://research.google.com/archive/mapreduce.html>
- Sanjay Ghemawat, Howard Gobioff, and Shun-Tak Leung: The Google File System
<http://research.google.com/archive/gfs.html>
- Siba Mohammad, Sebastian Breb, Eike Schallehn, “Cloud Data Management: A Short Overview and Comparison of Current Approaches,” 24th GI-Workshop on Foundations of Databases, May 2012. slides available at:
http://www.witi.cs.uni-magdeburg.de/iti_db/lehre/advddb/cloud.pdf
- Hadoop Application Architectures 1st Edition, by Mark Grover, Ted Malaska, Jonathan Seidman and Gwen Shapira, Publisher: O’Reilly Media, July 2015.